

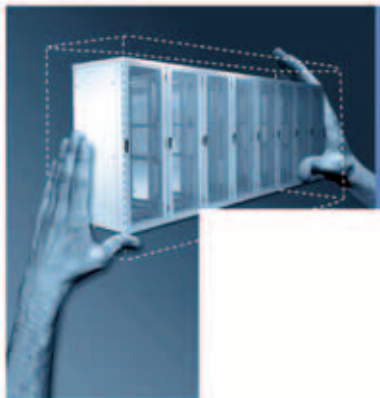

Catalogue 2007-2



Can you imagine life without electronics? Today, internet, telecom, e-mail and data processing strongly depend on electronics and are indispensable in our daily life! Minkels contributes to the obvious presence of Electronics in our daily life by offering high quality housing solutions for the Data Center and Telecom market.

Minkels is an international operating company, established in 1948. Headquarters is situated in Veghel, the Netherlands. Minkels also has local offices in the following countries: Belgium, Germany, England, France and Switzerland. Headquarters has several departments:

- Sales and Marketing
- Production and Assembly
- Research and Development
- Purchase and Logistics

With more than 125 employees at six branches throughout Europe, we develop high-quality, innovative housing systems that contribute to the success of our customers. Our system is based on creative innovation and flexibility, complemented by a keen eye for detail. We want to offer our customers complete solutions. Passion, commitment, and customer satisfaction make up the driving force behind our project teams. A combination of unique product concepts, state-of-the-art production techniques, added-value logistics, and a willing ear forms the basis for the success of Minkels.

Minkels has the ISO 9001 certificate.

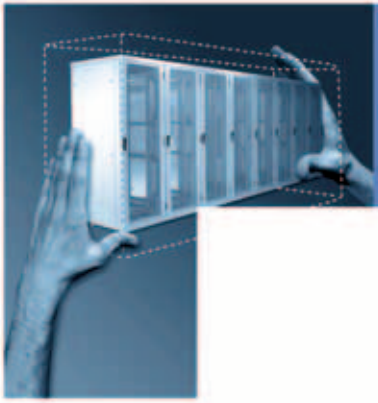

Minkels ICT is specialized in enclosures for IT-infrastructure in the Data Center and Telecom market. Our in-house created products have proven themselves over the last years and are widely used for housing servers and network equipment from all the main suppliers in the market. In the Data Center and Telecom market, there're specific demands concerning load capacity, stability, climate control, security and design. Minkels meets these specs by offering the right solutions for:

- Racks
- Cooling
- Security & Monitoring
- Power Management
- Cable Management

Our Varicon M® enclosures, Wall mounted enclosures and customer specific solutions, we always offer the best solution for our customers!



Contents

1. Varicon M®	5
2. Varicon M® - Pre-assembled cabinets	7
3. Varicon M® - Frame	11
4. Varicon M® - Base	15
5. Varicon M® - Top	25
6. Varicon M® - Front and rear	29
7. Varicon M® - Side	49
8. Varicon M® - Interior	53
9. Varicon M® - Accessories	61
10. Minkels LANRack	85
11. Wall enclosures	97
12. Electronic Locking Solutions	113
13. Rack Monitoring System	117
14. Cooling Solutions	121
15. Customised Solutions	133

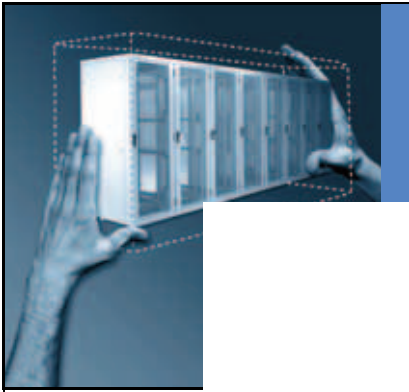

Varicon M[®], flexible housing solutions



Varicon M[®]

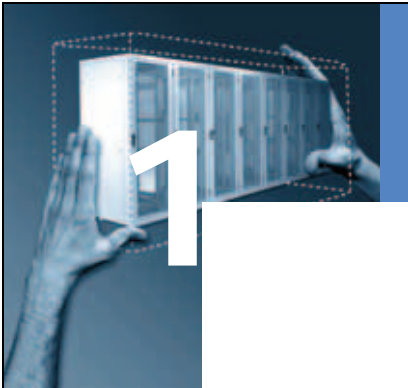

Varicon M[®], flexible housing solutions



6



The Varicon M[®] concept is mainly used for housing servers, network equipment and network cabling infrastructure. The design of the cabinet is advanced and modern.

With the "Frame+" concept you can simply choose a specific configuration yourselves out of the many standard building blocks. This fully assembled cabinet will be supplied to you within 5 working days!

The large variety in frame sizes, accessories and the logistic performance give the Varicon M[®] the flexibility you need!

Varicon M[®] is the perfect solution for housing:

- (Blade) Servers
- Switches
- Patch panels
- Routers
- Storage equipment

The aluminium frame can be disassembled if required, the 19"-interior is fully adjustable from inside the cabinet, there's a wide range of available accessories and excellent cooling solutions are being provided. Your equipment will fit in our cabinet properly!



All products in the Varicon M[®] concept are fully RoHS compliant.

Pre-assembled cabinets

Varicon M® - Pre-assembled cabinets

MINIKELS

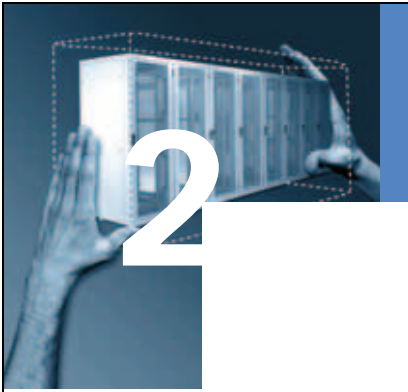

Pre-assembled cabinets

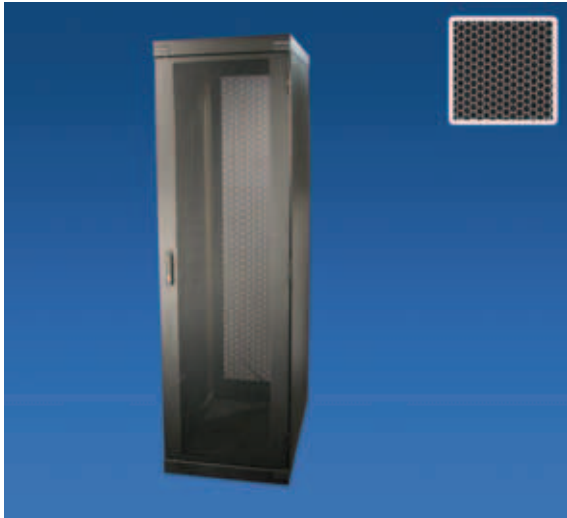

Dark server cabinets RAL 9011

These server cabinets are made in the colour RAL 9011 (anthracite). The cabinets are provided with 80% perforated front and back doors. For the best cooling results you have to offer the cool air in front of the cabinet, which will flow horizontal through the cabinet. There is a difference between stand-alone and baying cabinets. The stand-alone cabinets are delivered with side panels, these are dismountable. The baying cabinets are delivered without side panels, but with a baying kit. The cabinets are provided with 2-points cylinder locks (type EK-333) and 19-inch profiles. The 19-inch profiles are mounted at 50mm from the front and at a distance of 740mm. The roof has 3 blank cover plates.

8

<i>Unit</i>	<i>Height</i>	<i>Width</i>	<i>Depth</i>	<i>Color</i>	<i>Description</i>	<i>Part. no.</i>
<i>U</i>	<i>mm</i>	<i>mm</i>	<i>mm</i>			
41	2000	600	1000	RAL 9011	incl. 25mm base / incl. side panels	VMB416010S
41	2000	600	1000	RAL 9011	incl. 25mm base / baying type	VMB416010C
41	2000	800	1000	RAL 9011	incl. 25mm base / incl. side panels	VMB418010S
41	2000	800	1000	RAL 9011	incl. 25mm base / baying type	VMB418010C
46	2200	600	1000	RAL 9011	incl. 25mm base / incl. side panels	VMB226010S
46	2200	600	1000	RAL 9011	incl. 25mm base / baying type	VMB226010C
46	2200	800	1000	RAL 9011	incl. 25mm base / incl. side panels	VMB228010S
46	2200	800	1000	RAL 9011	incl. 25mm base / baying type	VMB228010C

Varicon M® - Pre-assembled cabinets

Co-Location cabinets

These cabinets are designed to host multiple customers safely together in one 19-inch cabinet. The perforated doors in both the front and rear create an optimum in airflow to cool down your equipment. You can choose 2 or 4 sections. If you choose 2 sections each section will be 22U. If you choose 4 sections each section will be 11U. The sections are separated by fixed mounted shelves, and have their own data and power cable duct. Each section and duct is safe from other sections, and has their own power strip (4 outlets). The cabinets are equipped with depth-adjustable, numbered 19-inch profiles, so you can rack almost any available server. The cabinet has a swivel handle grip with 2-point locking mechanism (lock not included).



<i>Unit</i>	<i>Height</i>	<i>Width</i>	<i>Depth</i>	<i>Color</i>	<i>Description</i>	<i>Part. no.</i>
<i>U</i>	<i>mm</i>	<i>mm</i>	<i>mm</i>			
46	2200	600	1000	RAL 7047	2 sections	MCL226010-2N
46	2200	600	1000	RAL 7047	4 sections	MCL226010-4N

9



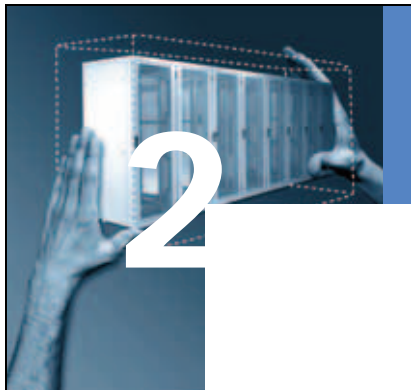

Cabinets 24h service

The express cabinets consist of an aluminium demountable basic frame with integrated 25mm base including adjustable feet. There is a difference between stand-alone and baying cabinets. The stand-alone cabinets are delivered with side panels, these are dismantable. The baying cabinets are delivered without side panels, but with a baying kit. The cabinets are fully earthed. The roof has 3 cut-outs with 2 cover plates and 1 cable brush. The cabinets are provided with four 19-inch profiles. The profiles are mounted 150mm at the front and 87,5mm at the back from the frame. The cabinets have a glass front door and a metal back door, both with a swivel handle Fix Easy. The doors hinge right.

In all the 1000mm deep cabinets the ventilated glass door will be replaced by a 65% perforated door. In these cabinets the 19-inch profiles are mounted 50mm at the front with a distance of 740mm.

The cabinets are delivered with caged nuts and screws.

10

Unit	Height	Width	Depth	Color	Description	Part. no.
U	mm	mm	mm			
25	1300	600	600	RAL 7047	Incl. side panels	VMC136060S
25	1300	600	800	RAL 7047	Incl. side panels	VMC136080S
25	1300	800	800	RAL 7047	Incl. side panels	VMC138080S
41	2000	600	1000	RAL 7047	Incl. side panels	VMC206010S
41	2000	600	1000	RAL 7047	Baying type	VMC206010C
41	2000	800	800	RAL 7047	Incl. side panels	VMC208080S
41	2000	800	800	RAL 7047	Baying type	VMC208080C
41	2000	800	1000	RAL 7047	Incl. side panels	VMC208010S
41	2000	800	1000	RAL 7047	Baying type	VMC208010C
46	2200	600	600	RAL 7047	Incl. side panels	VMC226060S
46	2200	600	800	RAL 7047	Incl. side panels	VMC226080S
46	2200	600	800	RAL 7047	Baying type	VMC226080C
46	2200	600	1000	RAL 7047	Incl. side panels	VMC226010S
46	2200	600	1000	RAL 7047	Baying type	VMC226010C
46	2200	800	800	RAL 7047	Incl. side panels	VMC228080S
46	2200	800	800	RAL 7047	Baying type	VMC228080C
46	2200	800	1000	RAL 7047	Incl. side panels	VMC228010S
46	2200	800	1000	RAL 7047	Baying type	VMC228010C

Frame

Extension kit

Varicon M® - Frame





Frame



Frames

The variable construction (frame-plus concept) guarantees a high stability and strength. The fully earthed frame makes it possible to build a cabinet for both the active as passive network solutions. The frame as standard comes with a base height of 25 mm. The option of a 100 mm base will raise the cabinet by a further 75 mm higher than stated in the table.

Frame material: Aluminum

Finishing frame: Powder coated

12

<i>Frame height U</i>	<i>Frame height mm</i>	<i>Depth mm</i>	<i>Colour</i>	<i>Width mm 600 Part. no.</i>	<i>Width mm 800 Part. no.</i>
12	700	600	RAL 7047	VMF076060	-
12	700	800	RAL 7047	VMF076080	-
16	900	600	RAL 7047	VMF096060	-
16	900	800	RAL 7047	VMF096080	-
21	1100	600	RAL 7047	VMF116060	-
21	1100	800	RAL 7047	VMF116080	-
25	1300	600	RAL 7047	VMF136060	VMF138060
25	1300	800	RAL 7047	VMF136080	VMF138080
25	1300	900	RAL 7047	VMF136090	VMF138090
25	1300	1000	RAL 7047	VMF1360100	VMF1380100
37	1800	600	RAL 7047	VMF186060	VMF188060
37	1800	800	RAL 7047	VMF186080	VMF188080
41	2000	600	RAL 7047	VMF206060	VMF208060
41	2000	800	RAL 7047	VMF206080	VMF208080
41	2000	900	RAL 7047	VMF206090	VMF208090
41	2000	1000	RAL 7047	VMF2060100	VMF2080100
41	2000	1000	RAL 9011	VMF2060100B	VMF2080100B
41	2000	1200	RAL 7047	VMF2060120	VMF2080120
41	2000	1200	RAL 9011	VMF2060120B	VMF2080120B
46	2200	600	RAL 7047	VMF226060	VMF228060
46	2200	800	RAL 7047	VMF226080	VMF228080

Varicon M® - Frame

<i>Frame height U</i>	<i>Frame height mm</i>	<i>Depth mm</i>	<i>Colour</i>	<i>Width mm 600 Part. no.</i>	<i>Width mm 800 Part. no.</i>
46	2200	900	RAL 7047	VMF226090	VMF228090
46	2200	1000	RAL 7047	VMF2260100	VMF2280100
46	2200	1000	RAL 9011	VMF2260100B	VMF2280100B
46	2200	1200	RAL 7047	VMF2260120	VMF2280120
46	2200	1200	RAL 9011	VMF2260120B	VMF2280120B

What's in the box: 1 frame



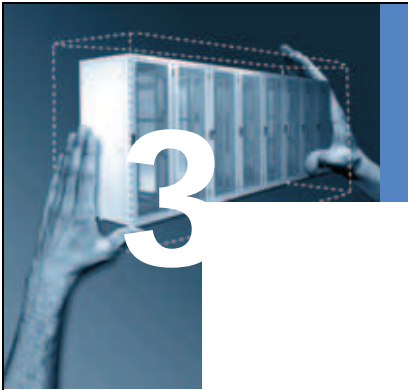

Extension kit



14

Extension kit

With this extension kit you can increase your cabinet depth by multiples of 100mm. This kit is easy to mount and the cabinet becomes 100mm wider. The kit can be mounted to the front or rear. Existing doors can be fitted to the extension kit itself. In this manner your Varicon M cabinet is future proof. 19-inch profiles can be placed in the extension kit. The standard base will fit into the extension kit.

Maximum weight: 425 kg

<i>Frame height</i>	<i>Width</i>		
<i>U</i>	<i>mm</i>	<i>Color</i>	<i>Part. no.</i>
41	600	RAL 7047	VMF206010
41	600	RAL 9011	VMF206010B
41	800	RAL 7047	VMF208010
41	800	RAL 9011	VMF208010B
46	600	RAL 7047	VMF226010
46	600	RAL 9011	VMF226010B
46	800	RAL 7047	VMF228010
46	800	RAL 9011	VMF228010B

What's in the box: 1 extension kit incl. mounting material and mounting instructions

Base

Base plate

Varicon M® - Base



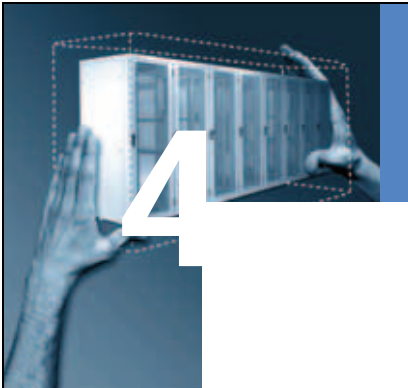

Base



Adjustable base legs

Four adjustable base legs are supplied for leveling the cabinet. The maximum weight stated in the table is for one set.

Material: Plastic

<i>Height</i>	<i>Maximum weight</i>	<i>Thread length</i>	<i>Part. no.</i>
<i>mm</i>	<i>kg</i>	<i>mm</i>	
25	850	60	MSM1001

What's in the box: 4 adjustable feet incl. mounting material

16



Plinths 25mm front/rear

Plinths are available in a perforated or blank version. Ventilated front/rear plinth with a height of 25 mm create an optimal airflow in the cabinet. Plinths are secured to the base by means of a 'click'-system and cover the adjustable feet.

<i>Width</i>	<i>type</i>	<i>Color</i>	<i>Part. no.</i>
<i>mm</i>			
600	Blank	RAL 7047	MSM1101
600	Blank	RAL 9011	MSM1101B
600	Perforated	RAL 7047	MSM1102
600	Perforated	RAL 9011	MSM1102B
800	Blank	RAL 7047	MSM1201
800	Blank	RAL 9011	MSM1201B
800	Perforated	RAL 7047	MSM1202
800	Perforated	RAL 9011	MSM1202B

What's in the box: 1 plinth

Varicon M® - Base

Plinths 25mm side

Blank plinths to cover the base legs and to support the side panel. They are secured to the base with screws.

Depth

<i>mm</i>	<i>Color</i>	<i>Part. no.</i>
600	RAL 7047	MSM1103
800	RAL 7047	MSM1203
900	RAL 7047	MSM1303
1000	RAL 7047	MSM1403
1000	RAL 9011	MSM1403B
1200	RAL 7047	MSM1503
1200	RAL 9011	MSM1503B



What's in the box: 1 plinth incl. fasteners

Extended base legs

If more space for ventilation or cable entry is required, base legs can be selected. Base legs are supplied with adjustable feet and can be used with plinths. Quantity is 4.

Finishing: Galvanised

Color: Sendzimir

Material: Sheet metal

Thickness: 2.0 mm

Height

<i>mm</i>	<i>kg</i>	<i>Part. no.</i>
100	850	MSM2001



What's in the box: 4 base legs, mounted, incl. mounting material



Plinths 100mm front/rear

Plinths are available in a perforated and blank version. The ventilated plinth is used to create an optimal airflow in the cabinet. To prevent dust, an optional filter set can be used. The filter set also fits the 100mm side plinths. Plinths are secured to the base legs with screws.

Width

<i>mm</i>	<i>type</i>	<i>Color</i>	<i>Part. no.</i>
600	Blank	RAL 7047	MSM2101
600	Blank	RAL 9011	MSM2101B
600	Perforated	RAL 7047	MSM2102
600	Perforated	RAL 9011	MSM2102B
600	Filterset		MSM2301
800	Blank	RAL 7047	MSM2201
800	Blank	RAL 9011	MSM2201B
800	Perforated	RAL 7047	MSM2202
800	Perforated	RAL 9011	MSM2202B
800	Filterset		MSM2302

What's in the box: 1 plinth incl. fasteners

18



Side plinths 100mm

Plinths to cover the base legs and to support the side panel. They are secured to the base with screws.

Depth

<i>mm</i>	<i>type</i>	<i>Color</i>	<i>Part. no.</i>
600	Blank	RAL 7047	MSM2103
600	Perforated	RAL 7047	MSM2104
800	Blank	RAL 7047	MSM2203
800	Perforated	RAL 7047	MSM2204
900	Blank	RAL 7047	MSM2403
1000	Blank	RAL 7047	MSM2503
1000	Blank	RAL 9011	MSM2503B
1000	Perforated	RAL 9011	MSM2504B
1200	Blank	RAL 9011	MSM2603B
1200	Perforated	RAL 9011	MSM2604B

What's in the box: 1 plinth incl. fasteners

Varicon M® - Base

Castors

If the cabinet is equipped with castors it is very easy to move the cabinet from one location to the other. A set of castor is available with or without brakes. The maximum weight illustrated is per set.

Construction height: 100 mm

Maximum weight: 400 kg

Housing material: Steel

Wheel material: Plastic



Type

Part. no.

4 castors without brakes	MSM3001
2 castors with brakes, 2 castors without brakes	MSM3002

What's in the box: 4 castors incl. mounting material

Plinths front/rear (in combination with castors)

Plinths can be used in combination with castors and are clipped to the base by means of a so-called 'click-system'.

type: Blank

Width

mm Part. no.

600	MSM3101
800	MSM3201

What's in the box: 1 plinth



Side plinths (in combination with castors)

Plinths can be used in combination with castors and are clipped to the base by using screws.

Depth

mm Part. no.

600	MSM3103
800	MSM3203
900	MSM3303
1000	MSM3403

What's in the box: 1 plinth incl. mounting material

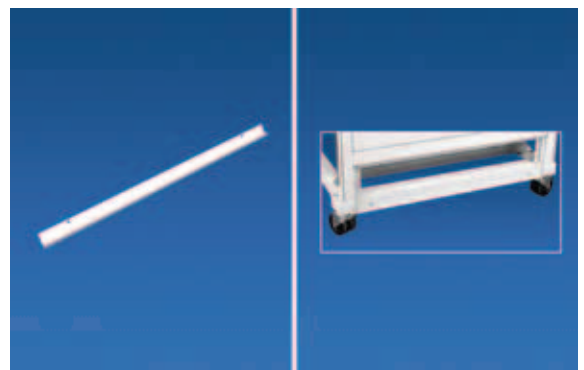

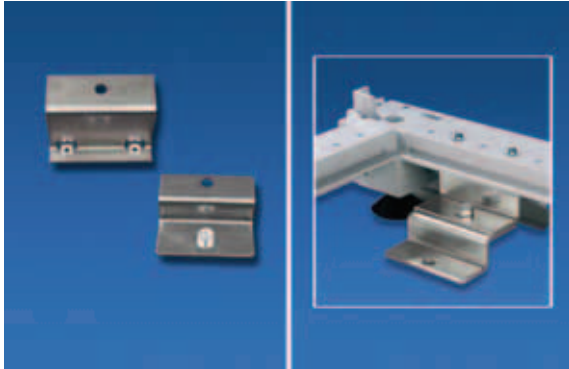
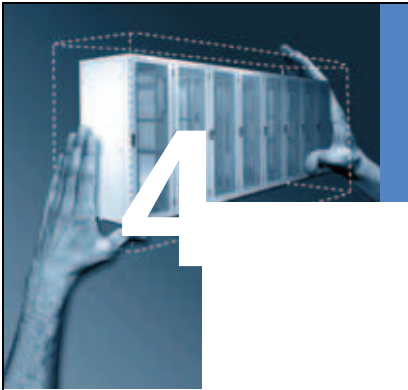

Floor fixation set

The floor fixation set will secure the frame to several floor types. If a computer floor is being used, we recommend a direct attachment to a lower floor, this is possible by using a length of stud. The stud is not included in this set.

Socket height

mm

Part. no.

25

MSM4100

What's in the box: 2 Z-profiles with integrated nuts, incl. mounting material

Base plate

Base plates

Base plates are available in blank versions or with three cut outs. The cut outs are modular and will accept cable entry brush, ventilation plate, blank plate or ventilation unit. With the 800mm width cabinets it is possible to use a blank plate or cable entry brush at the right and left of the bottom plate.

Thickness: 1.5 mm
 Cut-out depth: 122 mm
 Cut-out width: 405 mm

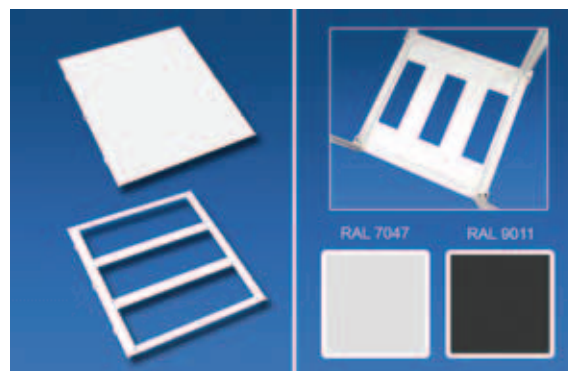

<i>Bottom plate width</i>	<i>Depth</i>		<i>Cut-outs</i>	<i># cut-outs</i>	<i>Color</i>	<i>Part. no.</i>
	<i>mm</i>	<i>mm</i>				
600/800	600		Cut-outs	3	RAL 7047	MBM0100
600/800	600		Blank	0	RAL 7047	MBM0110
600/800	800		Cut-outs	3	RAL 7047	MBM0101
600/800	800		Blank	0	RAL 7047	MBM0111
600/800	900		Cut-outs	3	RAL 7047	MBM0102
600/800	900		Blank	0	RAL 7047	MBM0112
600/800	1000		Cut-outs	3	RAL 7047	MBM0103
600/800	1000		Cut-outs	3	RAL 9011	MBM0103B
600/800	1000		Blank	0	RAL 7047	MBM0113
600/800	1200		Cut-outs	3	RAL 7047	MBM0104
600/800	1200		Cut-outs	3	RAL 9011	MBM0104B
600/800	1200		Blank	0	RAL 7047	MBM0114

What's in the box: 1 bottom plate incl. mounting material

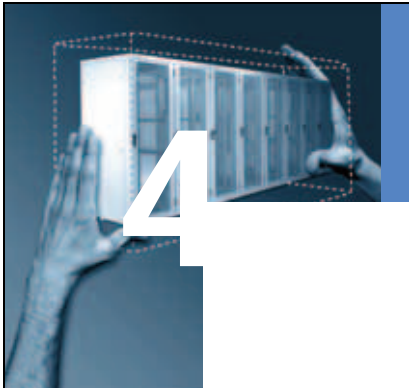

Base plates left / right, (800 mm width)

In the 800mm version there is a base plate and room for options as shown in the table below.

The stiffener profiles are used to support the base plate in case the 19-inch profiles are mounted using depth posts for divided 19-inch.

Location: Left/right

22

<i>type</i>	<i>Location</i>	<i>Depth</i> <i>mm</i>	<i>Color</i>	<i>Part. no.</i>
Blank	Left/right	600	RAL 7047	MBM0120
Blank	Left/right	800	RAL 7047	MBM0121
Blank	Left/right	900	RAL 7047	MBM0122
Blank	Left/right	1000	RAL 7047	MBM0123
Blank	Left/right	1000	RAL 9011	MBM0123B
Blank	Left/right	1200	RAL 7047	MBM0124
Blank	Left/right	1200	RAL 9011	MBM0124B
Brush	Left/right	600	Black	MBM0130
Brush	Left/right	800	Black	MBM0131
Brush	Left/right	900	Black	MBM0132
Brush	Left/right	1000	Black	MBM0133
Brush	Left/right	1200	Black	MBM0134
Cable pull relief	Left/right	600	RAL 7047	MBM0140
Cable pull relief	Left/right	800	RAL 7047	MBM0141
Cable pull relief	Left/right	900	RAL 7047	MBM0142
Stiffener profile	Left/right	600	RAL 7047	MBM0040
Stiffener profile	Left/right	800	RAL 7047	MBM0041
Stiffener profile	Left/right	900	RAL 7047	MBM0042
Stiffener profile	Left/right	1000	RAL 7047	MBM0043
Stiffener profile	Left/right	1000	RAL 9011	MBM0043B
Stiffener profile	Left/right	1200	RAL 7047	MBM0044
Stiffener profile	Left/right	1200	RAL 9011	MBM0044B

What's in the box: The blank, brush and cable pull relief are delivered as single pieces. The stiffener profiles are delivered per 2 incl. mounting material

Varicon M® - Base

Insert modules

Depending on the situation, you can choose optional modules for base or top cut-outs.

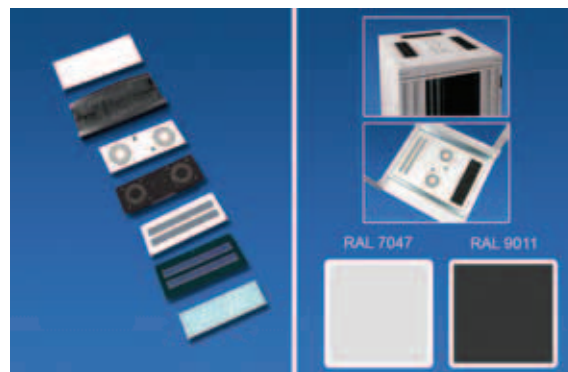

<i>Description</i>	<i>Technical data</i>	<i>Part. no.</i>
Cover plate RAL 7047	153 x 427 mm	MBM1001
Cover plate RAL 9011	153 x 427 mm	MBM1001B
Set of cable entry brushes	max opening 153 x 427 mm	MBM1003
Ventilation plate RAL 7047	Perorated surface 115 cm ² (slots)	MBM1005
Ventilation plate RAL 9011	Perorated surface 115 cm ² (slots)	MBM1005B
Filter set for ventilation plate	640 g/m ² dust collecting capacity	MBM1006
Fan unit including 2 fans and wiring RAL 7047	230VAC - 320m ³ /h - 44dB - 44Watt	MBM1007
Fan unit including 2 fans and wiring RAL 9011	230VAC - 320m ³ /h - 44dB - 44Watt	MBM1007B

What's in the box: single pieces incl. mounting material (if needed)

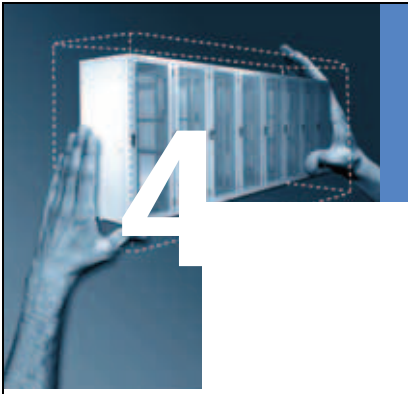

Top

Varicon M® - Top

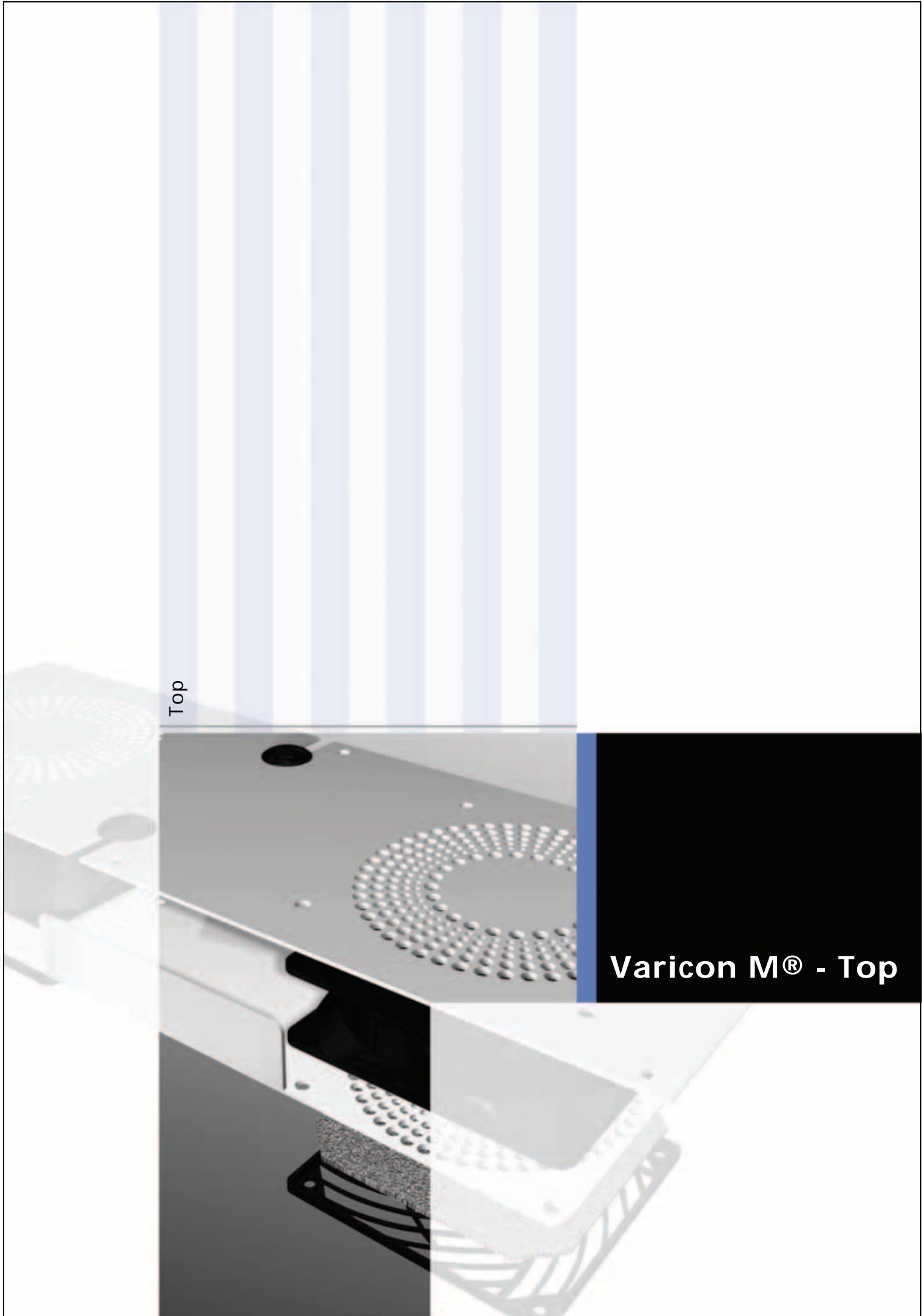

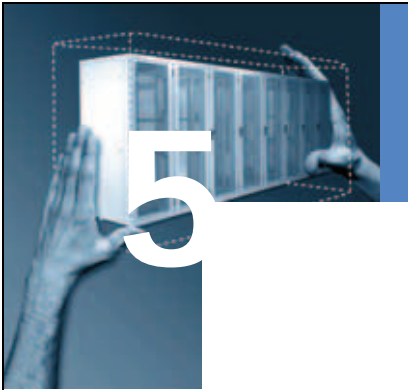

Top



Top ventilated

The top features 3 cut-outs which can be fitted with various inserts for cable-entry and/or ventilation. Ventilation slots are on three sides of the top. Cut outs are spread from left to right in 800mm wide roofs, or from front to back in the 600mm wide roofs. The 800mm cabinets are suitable for side cable entry.

Material: Steel
Finishing: Powder coated
Color: RAL 7047
Description: ventilated

26

<i>Width</i> <i>mm</i>	<i>Depth</i> <i>mm</i>	<i>cut out</i> <i>pcs</i>	<i>Part. no.</i>
600	600	3	MRF0021
600	800	3	MRF0022
800	600	3	MRF0123
800	800	3	MRF0124

What's in the box: 1 top incl. mounting material

Varicon M® - Top

Top blank

The top features 3 or 4 cut-outs which can be fitted with various inserts for cable-entry and/or ventilation. This type has no ventilation slots. Cut outs are spread from front to rear in the 600mm wide tops, or from left to right in 800mm wide tops.

Material: Steel

Finishing: Powder coated

Description: blank



<i>Width</i> <i>mm</i>	<i>Depth</i> <i>mm</i>	<i>cut out</i> <i>pcs</i>	<i>Color</i>	<i>Part. no.</i>
600	600	3	RAL 7047	MRF0017
600	800	3	RAL 7047	MRF0018
600	900	3	RAL 7047	MRF0025
600	1000	3	RAL 7047	MRF0027
600	1000	3	RAL 9011	MRF0027B
600	1200	3	RAL 7047	MRF0030
600	1200	3	RAL 9011	MRF0030B
800	600	3	RAL 7047	MRF0119
800	800	3	RAL 7047	MRF0120
800	900	4	RAL 7047	MRF0026
800	1000	4	RAL 7047	MRF0028
800	1000	4	RAL 9011	MRF0028B
800	1200	4	RAL 7047	MRF0029
800	1200	4	RAL 9011	MRF0029B

What's in the box: 1 top incl. mounting material

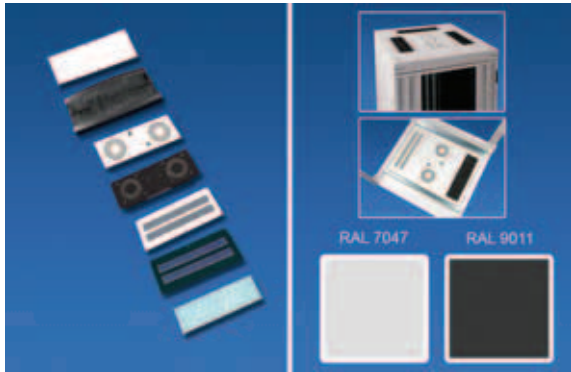
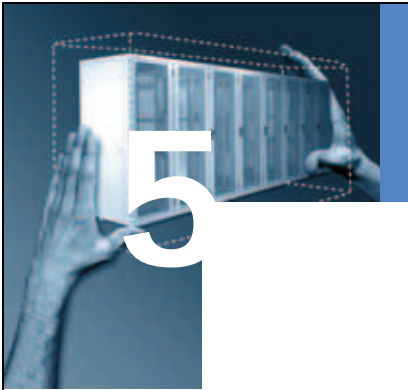

Insert modules

Depending on the situation, you can choose optional modules for base or top cut-outs.

28

<i>Description</i>	<i>Technical data</i>	<i>Part. no.</i>
Cover plate RAL 7047	153 x 427 mm	MBM1001
Cover plate RAL 9011	153 x 427 mm	MBM1001B
Set of cable entry brushes	max opening 153 x 427 mm	MBM1003
Ventilation plate RAL 7047	Perforated surface 115 cm ² (slots)	MBM1005
Ventilation plate RAL 9011	Perforated surface 115 cm ² (slots)	MBM1005B
Filter set for ventilation plate	640 g/m ² dust collecting capacity	MBM1006
Fan unit including 2 fans and wiring RAL 7047	230VAC - 320m ³ /h - 44dB - 44Watt	MBM1007
Fan unit including 2 fans and wiring RAL 9011	230VAC - 320m ³ /h - 44dB - 44Watt	MBM1007B

What's in the box: single pieces incl. mounting material (if needed)

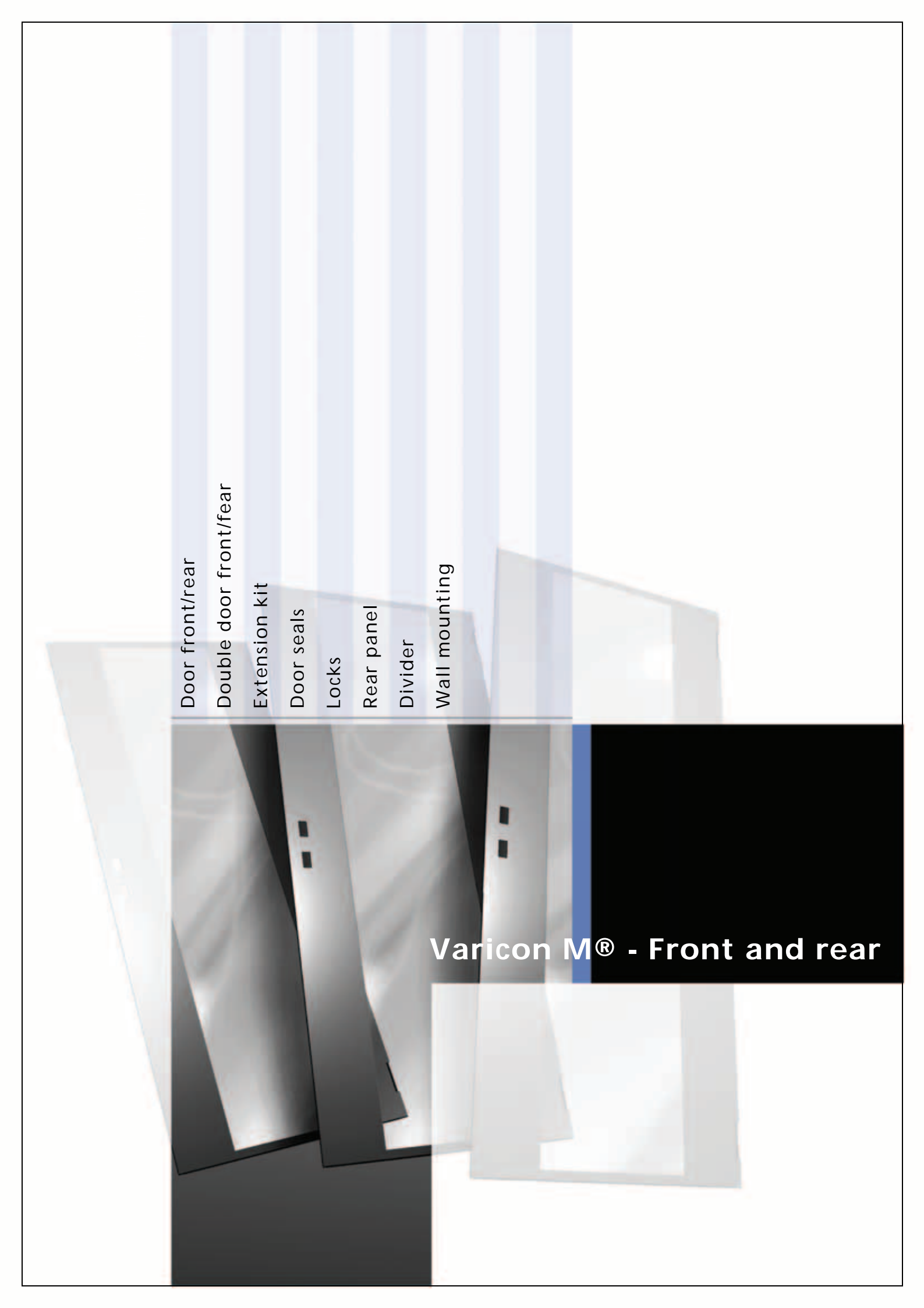

Door front/rear

Double door front/rear

Extension kit

Door seals

Locks

Rear panel

Divider

Wall mounting

Varicon M® - Front and rear

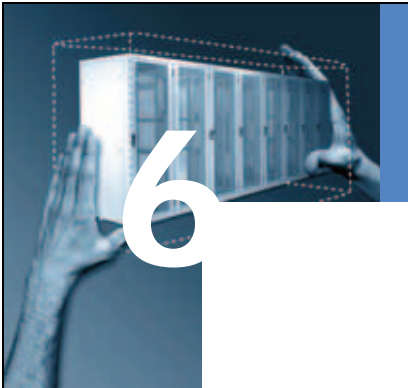

Door front/rear

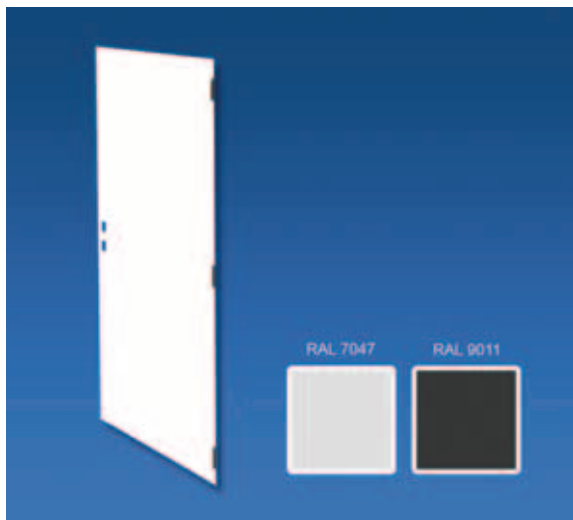

30

Solid doors

Solid steel door, hinged right. Locks not included.

Material: Sheet metal

Finishing: Powder coated

<i>Unit</i>	<i>Color</i>	<i>Width mm</i>	
		<i>600</i>	<i>800</i>
<i>U</i>		<i>Part. no.</i>	<i>Part. no.</i>
12	RAL 7047	MFD0001	
16	RAL 7047	MFD0002	
21	RAL 7047	MFD0003	
25	RAL 7047	MFD0004	MFD0104
37	RAL 7047	MFD0005	MFD0105
41	RAL 7047	MFD0006	MFD0106
41	RAL 9011	MFD0006B	MFD0106B
46	RAL 7047	MFD0007	MFD0107
46	RAL 9011	MFD0007B	MFD0107B

What's in the box: 1 door, hinges included (up to and including 25 HE are 2 hinges necessary, over 25 HE are 3 hinges necessary) incl. mounting material

Varicon M® - Front and rear

Doors 65% ventilated

Sheet metal door with a 65% perforated surface. The perforation width is equal to the 19-inch standard. The locking mechanism are ordered separately. Hinges are included. Doors are hinged right as standard.

Material: Sheet metal

Finishing: Powder coated



<i>Unit</i>	<i>Color</i>	<i>Width mm</i>	
		<i>600</i>	<i>800</i>
<i>U</i>		<i>Part. no.</i>	<i>Part. no.</i>
25	RAL 7047	MFD6014	MFD6114
41	RAL 7047	MFD6016	MFD6116
41	RAL 9011	MFD6016B	MFD6116B
46	RAL 7047	MFD6017	MFD6117
46	RAL 9011	MFD6017B	MFD6117B

What's in the box: 1 door, hinges included (up to and including 25 HE are 2 hinges necessary, over 25 HE are 3 hinges necessary) incl. mounting material

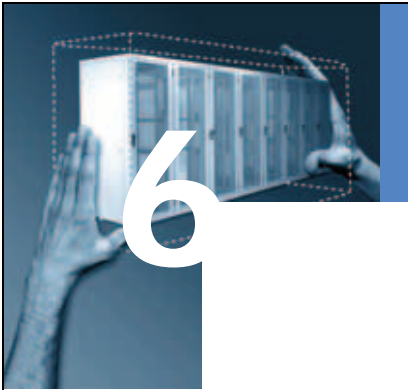

Doors 80% ventilated

The sheet metal door has a maximum perforation surface of 80%. This perforation rate guarantees an optimal air flow. The 600mm wide door has a perforation width of ± 445 mm. The 800mm wide door has a perforation width of ± 585 mm. The locking mechanism are ordered separately. Hinges are included. Doors are hinged right as standard.

Material: Sheet metal

Finishing: Powder coated

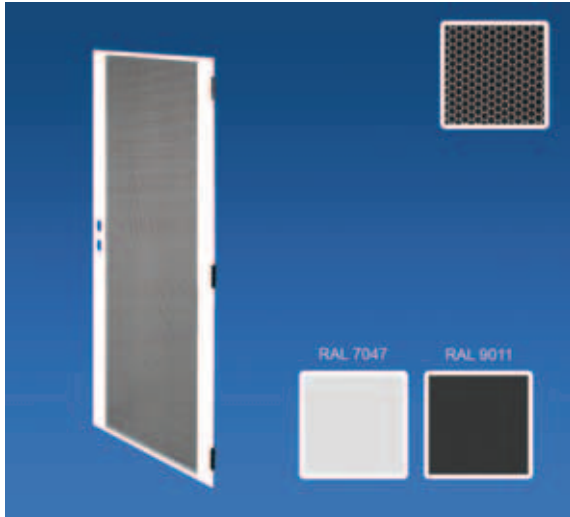

32

<i>Unit</i>	<i>Color</i>	<i>Width mm</i>	<i>Width mm</i>
		<i>600</i>	<i>800</i>
<i>U</i>		<i>Part. no.</i>	<i>Part. no.</i>
41	RAL 7047	MFD7006	MFD7106
41	RAL 9011	MFD7006B	MFD7106B
46	RAL 7047	MFD7007	MFD7107
46	RAL 9011	MFD7007B	MFD7107B

What's in the box: 1 door, hinges included (up to and including 25 HE are 2 hinges necessary, over 25 HE are 3 hinges necessary) incl. mounting material

Varicon M® - Front and rear

Glazed doors (grey tinted)

Steel frame with grey tinted safety glass panel. The strip covers the 19-inch profiles. The locking mechanism are ordered separately. Doors are hinged right as standard.

Material: Sheet metal

Finishing: Powder coated



<i>Unit</i>	<i>Color</i>	<i>Width mm</i>	
		<i>600</i>	<i>800</i>
<i>U</i>		<i>Part. no.</i>	<i>Part. no.</i>
12	RAL 7047	MFD2001	
16	RAL 7047	MFD2002	
21	RAL 7047	MFD2003	
25	RAL 7047	MFD2004	MFD2104
37	RAL 7047	MFD2005	MFD2105
41	RAL 7047	MFD2006	MFD2106
46	RAL 7047	MFD2007	MFD2107

What's in the box: 1 door, hinges included (up to and including 25 HE are 2 hinges necessary, over 25 HE are 3 hinges necessary) incl. mounting material

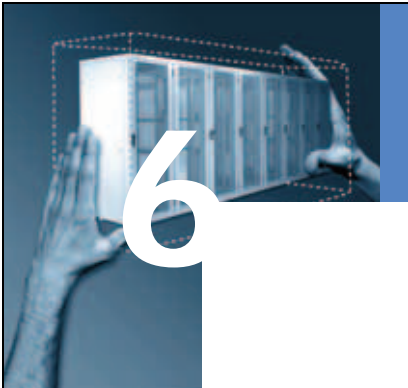

Glazed doors (clear)

Steel frame with clear safety glass panel. The locking mechanism are ordered separately. Hinges are included. Doors are hinged right as standard.

Material: Sheet metal

Finishing: Powder coated



34

<i>Unit</i>	<i>Color</i>	<i>Width mm</i> <i>600</i> <i>Part. no.</i>	<i>Width mm</i> <i>800</i> <i>Part. no.</i>
12	RAL 7047	MFD1001	
16	RAL 7047	MFD1002	
21	RAL 7047	MFD1003	
25	RAL 7047	MFD1004	MFD1104
37	RAL 7047	MFD1005	MFD1105
41	RAL 7047	MFD1006	MFD1106
41	RAL 9011	MFD1006B	MFD1106B
46	RAL 7047	MFD1007	MFD1107
46	RAL 9011	MFD1007B	MFD1107B

What's in the box: 1 door, hinges included (up to and including 25 HE are 2 hinges necessary, over 25 HE are 3 hinges necessary) incl. mounting material

Varicon M® - Front and rear

Glazed doors ventilated (grey tinted)

Steel frame with perforation and grey tinted safety glass panel. The strip covers the 19-inch profiles. The locking mechanism is ordered separately. Doors are hinged right as standard.

Material: Sheet metal

Finishing: Powder coated

Color: RAL 7047

<i>Unit</i>		<i>Width mm</i>
<i>U</i>	<i>Color</i>	<i>Part. no.</i>
25	RAL 7047	MFD4114
41	RAL 7047	MFD4116
46	RAL 7047	MFD4117



What's in the box: 1 door, hinges included (up to and including 25 HE are 2 hinges necessary, over 25 HE are 3 hinges necessary) incl. mounting material

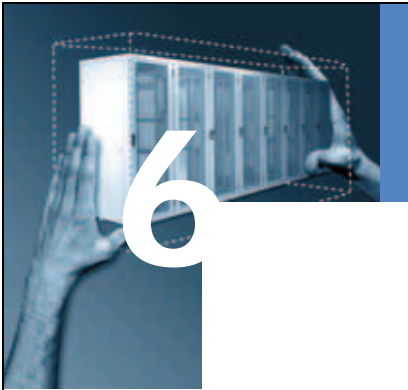

Double door front/fear



36

Double doors blank incl 2-point lock

Two-leaf steel plate door, blank type. The double door provides easy access to the cabinet, with a minimum turning circle. In that way the room in the cabinet is maximised. The two point locking mechanism and swivel handle are included. A lock for the swivel handle is ordered separately. Hinges are included.

Material: Sheet metal

Finishing: Powder coated

Color: RAL 7047

<i>Unit</i>	<i>Color</i>	<i>Width mm</i>	<i>Width mm</i>
		<i>600</i>	<i>800</i>
<i>U</i>		<i>Part. no.</i>	<i>Part. no.</i>
41	RAL 7047	MDD0006	MDD0106
46	RAL 7047	MDD0007	MDD0107

What's in the box: 1 door, consists of a left and right turning part, 6 hinges, incl. mounting material

Varicon M® - Front and rear

Double doors 65% ventilated

Two-leaf steel plate door, 65% ventilated to create airflow to or from your equipment. The double door provides easy access to the cabinet, with a minimum turning circle. The two point locking mechanism and swivel handle are included. A lock for the swivel handle is ordered separately. Hinges are included.

Material: Sheet metal

Finishing: Powder coated

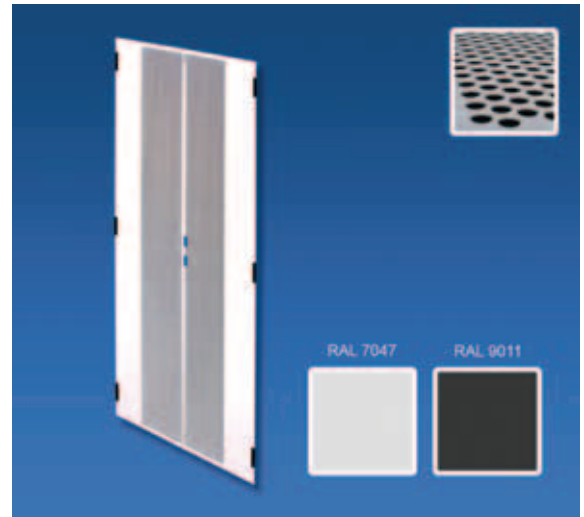

<i>Unit</i>	<i>Color</i>	<i>Width mm</i>	
		<i>600</i>	<i>800</i>
<i>U</i>		<i>Part. no.</i>	<i>Part. no.</i>
41	RAL 7047	MDD3016	MDD3116
41	RAL 9011	MDD3016B	MDD3116B
46	RAL 7047	MDD3017	MDD3117
46	RAL 9011	MDD3017B	MDD3117B

What's in the box: 1 door, consists of a left and right turning part, 6 hinges, incl. mounting material

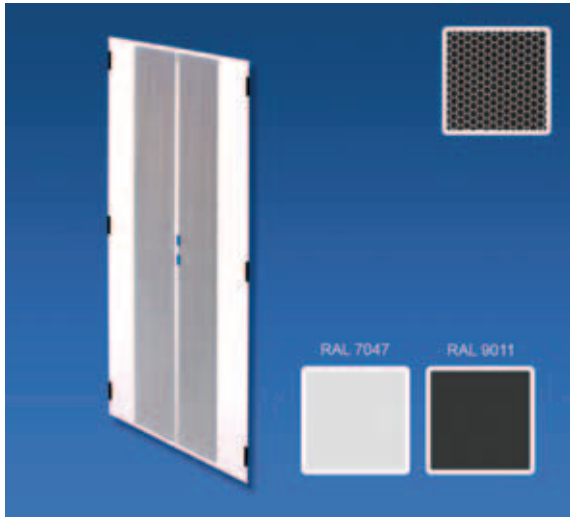
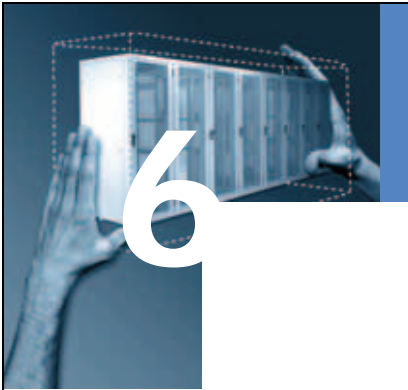

Double doors 80% ventilated

Two-leaf steel plate door, 80% ventilated to create airflow to or from your equipment. The double door provides easy access to the cabinet, with a minimum turning circle. The two point locking mechanism and swivel handle are included. A lock for the swivel handle is ordered separately. Hinges are included.

Material: Sheet metal

Finishing: Powder coated

38

<i>Unit</i>	<i>Color</i>	<i>Width mm</i> <i>600</i> <i>Part. no.</i>	<i>Width mm</i> <i>800</i> <i>Part. no.</i>
41	RAL 7047	MDD7006	MDD7106
41	RAL 9011	MDD7006B	MDD7106B
46	RAL 7047	MDD7007	MDD7107
46	RAL 9011	MDD7007B	MDD7107B

What's in the box: 1 door, consists of a left and right turning part, 6 hinges, incl. mounting material

Varicon M® - Front and rear

Double doors glass incl 2-point lock (grey tinted)

Two-leaf steel glass door, the glass is grey tinted. The double glass door provides easy access to the cabinet, with a minimum turning circle, it enlarges the amount of space and enables optimal use of your computer room or patch room. The two point locking mechanism and swivel handle are included. A lock for the swivel handle is ordered separately. Hinges are included.

Material: Sheet metal

Finishing: Powder coated

Color: RAL 7047



<i>Unit</i>		<i>Width mm</i>	<i>Width mm</i>
<i>U</i>	<i>Color</i>	<i>Part. no.</i>	<i>Part. no.</i>
41	RAL 7047	MDD1016	MDD1116
46	RAL 7047	MDD1017	MDD1117

What's in the box: 1 door, consists of a left and right turning part, 6 hinges, incl. mounting material

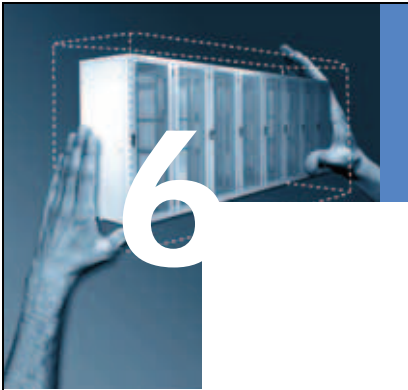

Extension kit



40

Extension kit

With this extension kit you can increase your cabinet depth by multiples of 100mm. This kit is easy to mount and the cabinet becomes 100mm wider. The kit can be mounted to the front or rear. Existing doors can be fitted to the extension kit itself. In this manner your Varicon M cabinet is future proof. 19-inch profiles can be placed in the extension kit. The standard base will fit into the extension kit.

Maximum weight: 425 kg

<i>Frame height</i>	<i>Width</i>		
<i>U</i>	<i>mm</i>	<i>Color</i>	<i>Part. no.</i>
41	600	RAL 7047	VMF206010
41	600	RAL 9011	VMF206010B
41	800	RAL 7047	VMF208010
41	800	RAL 9011	VMF208010B
46	600	RAL 7047	VMF226010
46	600	RAL 9011	VMF226010B
46	800	RAL 7047	VMF228010
46	800	RAL 9011	VMF228010B

What's in the box: 1 extension kit incl. mounting material and mounting instructions

Door seals

Optional seals

The optional rubber door seals can be used at the left or right side. It provides an optimal climate in your cabinet, reduces sound and reduces the amount of dust in the cabinet.

Material: Rubber

Color: Black

Unit

<i>U</i>	<i>Part. no.</i>
12	MFR0001
16	MFR0002
21	MFR0003
25	MFR0004
37	MFR0005
41	MFR0006
46	MFR0007



What's in the box: 1 rubber sealing, self-adhesive

6

Locks



Locking systems - new

Locking system for front and rear doors. Different types are available. In the picture you'll see from left to right the following locks: lock blind, cylinder, swivel handle and swivel handle with combination lock. When ordering the swivel handle, note that the lock should be ordered separately. However, excluding the swivel handle with combination lock.

Unique cylinder locks are available for combination locks. Price and delivery period are at request.

42

<i>Lock type</i>	<i># locking points</i>	<i>Unit</i>	<i>Part. no.</i>
Swivel handle Fix Easy	2-points	12 and 16	MLK0501
Swivel handle Fix Easy	2-points	21 and 25	MLK0502
Swivel handle Fix Easy	2-points	37, 41 and 46	MLK0503
Lock blind Fix Easy	2-points	12 and 16	MLK0511
Lock blind Fix Easy	2-points	21 and 25	MLK0512
Lock blind Fix Easy	2-points	37, 41 and 46	MLK0513
Cylinder Fix Easy	2-points	12 and 16	MLK0521
Cylinder Fix Easy	2-points	21 and 25	MLK0522
Cylinder Fix Easy	2-points	37, 41 and 46	MLK0523
Swivel handle Fix Easy with combination lock	2-points	12 and 16	MLK0531
Swivel handle Fix Easy with combination lock	2-points	21 and 25	MLK0532
Swivel handle Fix Easy with combination lock	2-points	37, 41 and 46	MLK0533

What's in the box: single pieces incl. mounting material

Varicon M® - Front and rear

Locking systems

Locking system for front and rear doors. Choose from 1-point or 2-point locking mechanism. Different types are available. In the picture you'll see from left to right the following locks: lock blind, cylinder, swivel handle and swivel handle with combination lock. When ordering the swivel handle, note that the lock should be ordered separately. However, excluding the swivel handle with combination lock.

Unique cylinder locks are available for combination locks. Price and delivery period are at request.



**These locking systems are only suitable for the old door types.
For more information, please contact us.**

<i>Lock type</i>	<i># locking points</i>	<i>Unit</i>	
		<i>U</i>	<i>Part. no.</i>
Lock blind	1-point	0	MLK0100
Lock blind	2-points	25	MLK0104
Lock blind	2-points	37	MLK0105
Lock blind	2-points	41	MLK0106
Lock blind	2-points	46	MLK0107
Cylinder	1-point	0	MLK0200
Cylinder	2-points	25	MLK0204
Cylinder	2-points	37	MLK0205
Cylinder	2-points	41	MLK0206
Cylinder	2-points	46	MLK0207
Swivel handle	1-point	0	MLK0300
Swivel handle	2-points	25	MLK0304
Swivel handle	2-points	37	MLK0305
Swivel handle	2-points	41	MLK0306
Swivel handle	2-points	46	MLK0307
Swivel handle with combination lock	1-point	0	MLK0320
Swivel handle with combination lock	2-points	25	MLK0324
Swivel handle with combination lock	2-points	37	MLK0325
Swivel handle with combination lock	2-points	41	MLK0326
Swivel handle with combination lock	2-points	46	MLK0327

What's in the box: single pieces incl. mounting material

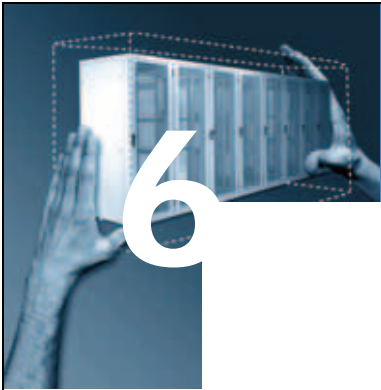

Type of lock for swivel handle

Lock choice for swivel handle grip.

<i>Description</i>	<i>Part. no.</i>
Blank	MLK9001
with key sq-6	MLK9002
Cylinder lock - EK-333	MLK9003
Wilka cylinder	MLK9004

What's in the box: 1 lock, 2 keys (if needed), incl. mounting material

Varicon M® - Front and rear

Rear panel

Rear panels

Square 6 locks enable the panels to be removed quickly. The rear panel is manufactured blank to assist venting through the top panel.

Material: Sheet metal

Finishing: Powder coated

Color: RAL 7047

<i>Unit</i>	<i>Width mm</i>	<i>Width mm</i>
<i>U</i>	<i>Part. no.</i>	<i>Part. no.</i>
12	MRP0001	-
16	MRP0002	-
21	MRP0003	-
25	MRP0004	MRP0104
37	MRP0005	MRP0105
41	MRP0006	MRP0106
46	MRP0007	MRP0107



45

What's in the box: 1 panel, 2 locks square 6mm (12-25HE), 4 locks square 6mm (37-46HE)

Cylinder lock

The cylinder lock replaces the square lock. The cylinder lock gives extra security to the side panels. When the cabinet is 37 HE or higher, use four cylinder locks, when the cabinet is lower two.

<i>Description</i>	<i>Part. no.</i>
simple cylinder lock	MSP0199

What's in the box: 1 cylinder and 2 keys

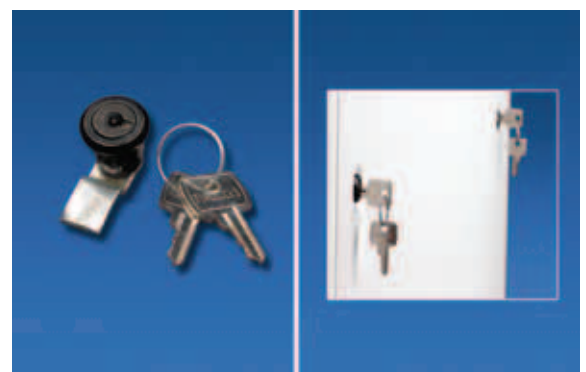

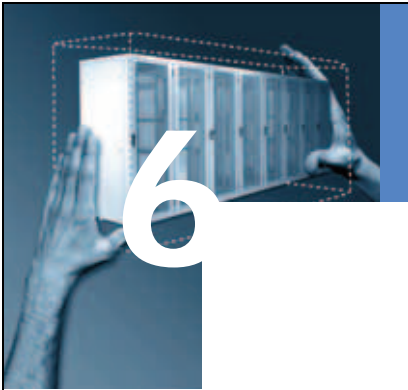

Divider



Profiles for dividing the rear side

Profile for dividing the rear panel. By combining the profile with a rear panel that is smaller than the cabinet, it is possible to create an open space in the bottom or top of the cabinet. This open space can be used for cable entry.

Material: Sheet metal

Finishing: Powder coated

Color: RAL 7047

Width

<i>mm</i>	<i>Part. no.</i>
-----------	------------------

600	MRA0001
-----	---------

800	MRA0002
-----	---------

What's in the box: 1 profile incl. mounting material

Varicon M® - Front and rear

Wall mounting

Wall mounting

A set of brackets to attach your Varicon M cabinet to the wall, the brackets support the top and bottom of the frame. Suitable for cabinets higher than 21 U or 37 ME. Template included.

Material: Sheet metal

Finishing: Powder coated

Color: RAL 7047



Width

<i>mm</i>	<i>Part. no.</i>
600	MRW0001

What's in the box: 2 brackets incl. mounting material for the cabinet

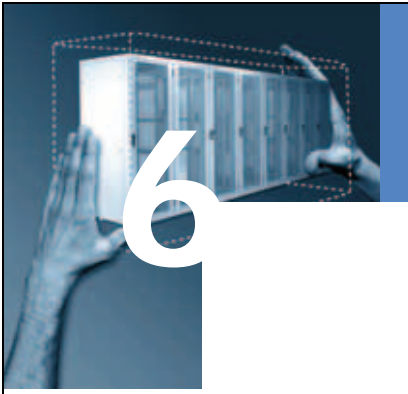

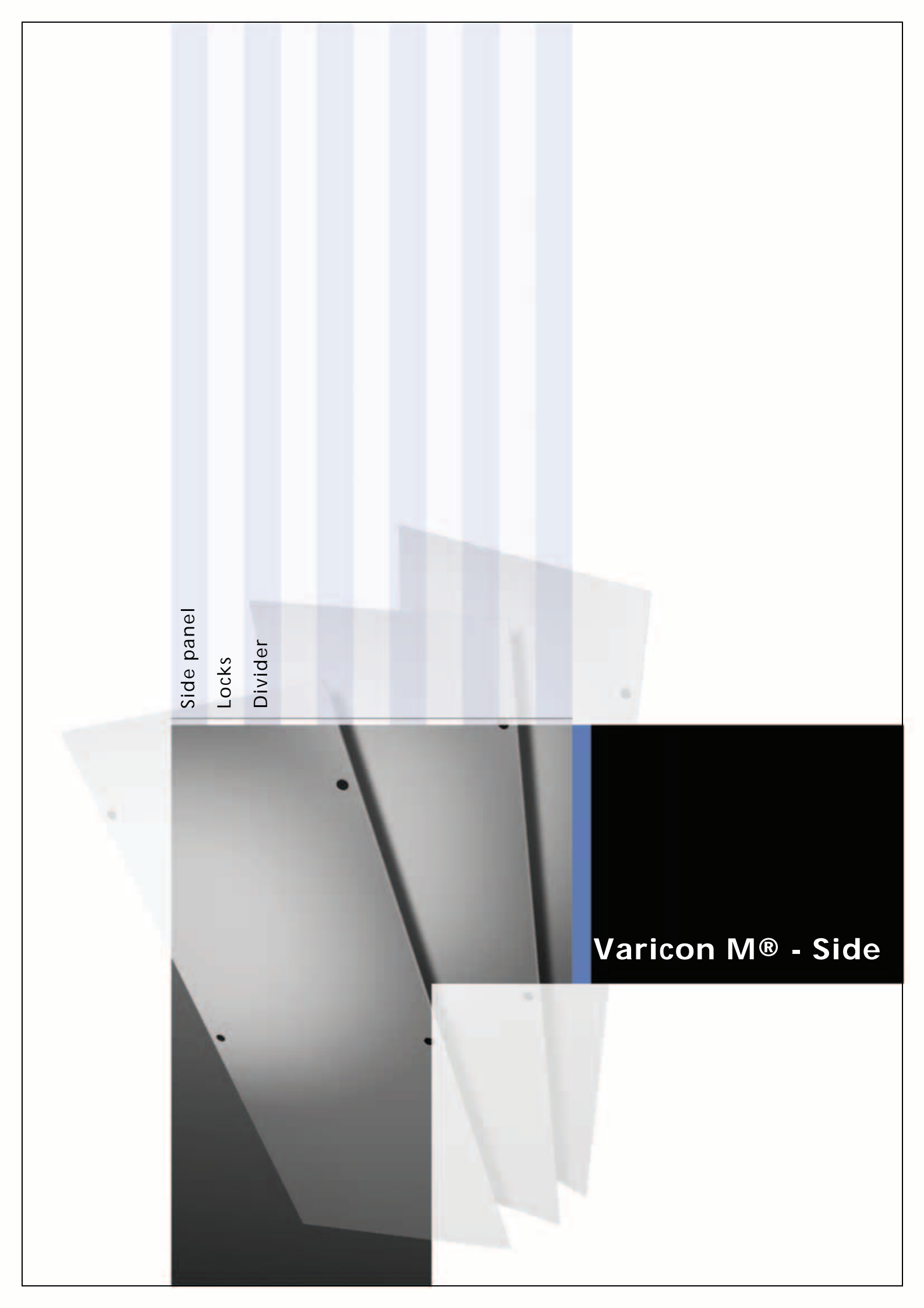

Side panel

Locks

Divider

Varicon M® - Side

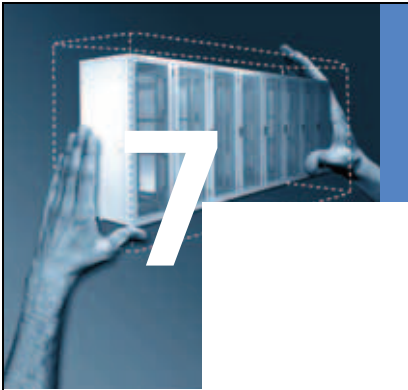

Side panel

Side panels

Side panels are manufactured blank. Square 6 locks ensure that the side panel can be removed quickly. A side plinth is necessary when mounting a side panel.

By the 1200mm deep frames the side exists of two parts.

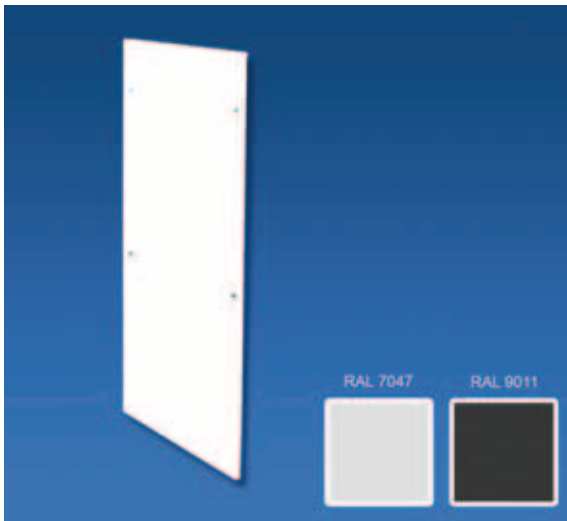

50

Unit U	Color	Depth mm	Depth mm	Depth mm	Depth mm	Depth mm
		600	800	900	1000	1200
		Part. no.	Part. no.	Part. no.	Part. no.	Part. no.
12	RAL 7047	MSP0001	MSP0101			
16	RAL 7047	MSP0002	MSP0102			
21	RAL 7047	MSP0003	MSP0103			
25	RAL 7047	MSP0004	MSP0104	MSP0204	MSP0304	
37	RAL 7047	MSP0005	MSP0105			
41	RAL 7047	MSP0006	MSP0106	MSP0206	MSP0306	MSP0406
41	RAL 9011				MSP0306B	MSP0406B
46	RAL 7047	MSP0007	MSP0107	MSP0207	MSP0307	MSP0407
46	RAL 9011				MSP0307B	MSP0407B

What's in the box: 1 panel, 2 locks, square 6mm (12-25HE), 4 locks square 6mm (37-46HE)

Locks

Cylinder lock

The cylinder lock replaces the square lock. The cylinder lock gives extra security to the side panels. When the cabinet is 37 HE or higher, use four cylinder locks, when the cabinet is lower two.

Description	Part. no.
simple cylinder lock	MSP0199

What's in the box: 1 cylinder and 2 keys

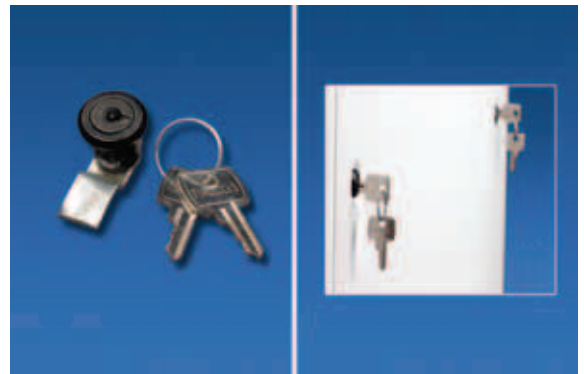

Internal locking mechanism

Side panels can only be locked and unlocked from the inside with this internal locking mechanism, it prevents unauthorised access to the cabinet. When the cabinet is 37 U or higher use two locks, when lower use one.

Depth	Location	Part. no.
600	Left	MSA0001
600	Right	MSA0002
800	Left	MSA0101
800	Right	MSA0102
900	Left	MSA0201
900	Right	MSA0202
1000	Left	MSA0301
1000	Right	MSA0302

What's in the box: 1 internal locking mechanism incl. mounting material





Divider



Profiles for dividing the side panel

Profile for dividing the side panel. By combining the profile with a standard side panel, which is smaller than the cabinet, you can create an open space on the top or bottom of the cabinet.

Material: Sheet metal

Finishing: Powder coated

Color: RAL 7047

Width

<i>mm</i>	<i>Part. no.</i>
600	MSA0100
800	MSA0200

What's in the box: 1 profile incl. mounting material

Profiles
Construction

Varicon M® - Interior





Profiles

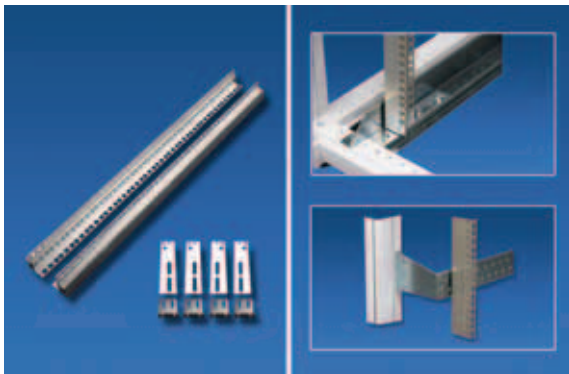

19-inch profiles

The 19-inch profiles are supplied with a hole configuration at the front and side to enable mounting equipment and accessories. The aluminium extrusion guarantees a high strength. Another advantage for mounting from the inside of the cabinet is quick change and easy adjustment.

Material: Aluminum

Finishing: Chromatized

Unit

<i>U</i>	<i>Part. no.</i>
12	MPR0501
16	MPR0502
21	MPR0503
25	MPR0504
37	MPR0505
41	MPR0506
46	MPR0507

What's in the box: 2 19-inch profiles, 4 brackets for application 1, 4 brackets for application 2, incl. mounting material

Varicon M® - Interior

Metric profiles

For mounting metric equipment and/or accessories you can choose metric profiles which have to be mounted on mounting depth posts (at least 4). Metric profiles are provided with punched holes.

Material: Steel

Finishing: Galvanised

Unit (Metric)

<i>ME</i>	<i>Part. no.</i>
21	MPR1001
29	MPR1002
37	MPR1003
45	MPR1004
65	MPR1005
73	MPR1006
81	MPR1007

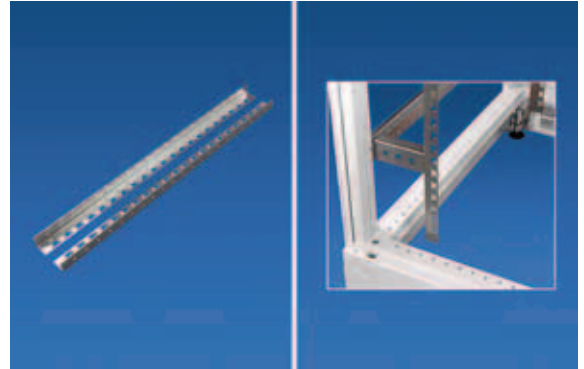

What's in the box: 2 profiles incl. mounting material

Number strips

The number strip is used to indicate the heights.

<i>Description</i>	<i>Part. no.</i>
Number strip for 19-inch profile 46U	MPR0060
Number strip for metric profile 81ME	MPR0061

What's in the box: 1 number strip

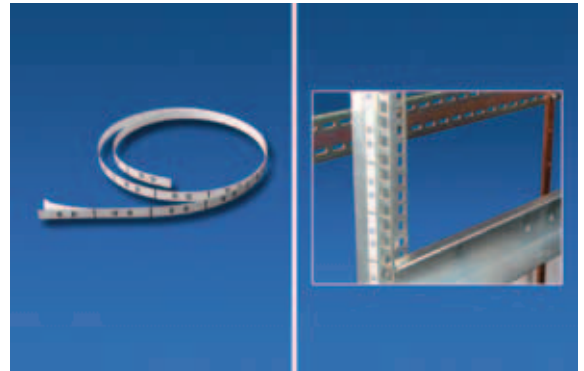



Construction



Depth posts t/b 800mm (w)

Set of 4 brackets to help assembly and adjustment of the 19-inch profiles. The brackets are mounted on the top and bottom window. Depth posts are suitable for large servers.

Location: Depth
 Material: Sheet metal
 Finishing: Galvanised
 Width: 800 mm

<i>Location</i>	<i>Depth</i> <i>mm</i>	<i>Part. no.</i>
Depth	600	MPR0160
Depth	800	MPR0161
Depth	900	MPR0162
Depth	1000	MPR0163
Depth	1200	MPR0164

What's in the box: 4 depth posts incl. mounting material

56



Depth posts for divided 19-inch - 800 (w)

Set of 4 brackets to support the 19-inch profiles in 800mm wide cabinets. Because of their design and bearing ability (450 kilo) they are suitable to support the 19-inch profiles.

Location: Left/right
 Material: Sheet metal
 Finishing: Galvanised
 Width: 800 mm

<i>Location</i>	<i>Depth</i> <i>mm</i>	<i>Part. no.</i>
Left/right	600	MPR1170
Left/right	800	MPR1171
Left/right	900	MPR1172
Left/right	1000	MPR1173
Left/right	1200	MPR1174

What's in the box: 4 depth posts side-mounted, 4 support spacers left, 4 support spacers right, incl. mounting material

Varicon M® - Interior

Depth posts for divided 19-inch - 600 (w)

Set of 4 brackets to help the 19-inch profiles to split a 600mm cabinet.
Maximum bear load with this solution is 450 kg.

Location: Left/right
Material: Sheet metal
Finishing: Galvanised
Width: 600 mm

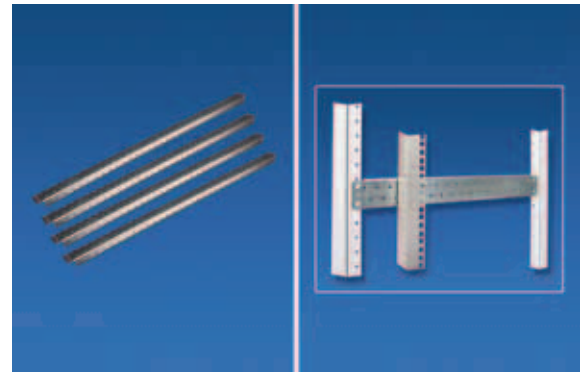

<i>Location</i>	<i>Depth mm</i>	<i>Part. no.</i>
Left/right	600	MPR0170
Left/right	800	MPR0171
Left/right	900	MPR0172
Left/right	1000	MPR0173

What's in the box: 4 depth posts incl. mounting material

57

Stability posts 19-inch

The stability posts are secured to the 19-inch profiles, they provide added strength and support when heavy equipment is to be used. As a rule the stability posts are mounted in the middle of the cabinet (in height direction).

Material: Sheet metal
Finishing: Galvanised

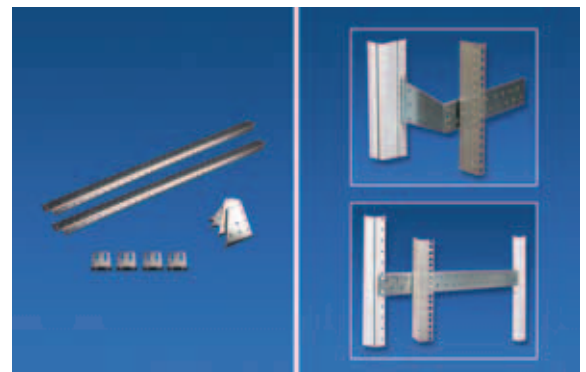

<i>Depth mm</i>	<i>Width mm</i>	
	<i>600</i>	<i>800</i>
	<i>Part. no.</i>	<i>Part. no.</i>
600	MPR0180	MPR1180
800	MPR0181	MPR1181
900	MPR0182	MPR1182
1000	MPR0183	MPR1183
1200	MPR0184	MPR1184

What's in the box: 2 x stability posts, 4 brackets, incl. mounting material.
The 800mm stability posts are delivered with 4 support spacers

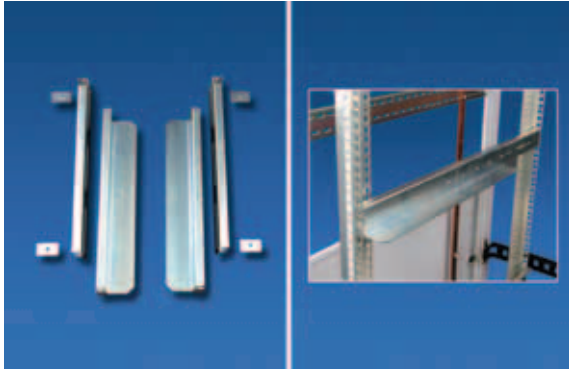

Corner guide rails

Variable corner guide rails with variable fixing that uses only 1U mounting space. Variable fixing means the depth of the corner guide rail does not have to be equal to the depth between the 19-inch profiles. The edge is 40mm which supports network equipment.

Material: Sheet metal

Finishing: Galvanised

Maximum weight: 100 kg

Construction depth

<i>mm</i>	<i>Part. no.</i>
300 - 450	MPR0311
450 - 750	MPR0312
740 - 1050	MPR0313

What's in the box: 1 corner guide rail left and 1 corner guide rail right incl. mounting material

58

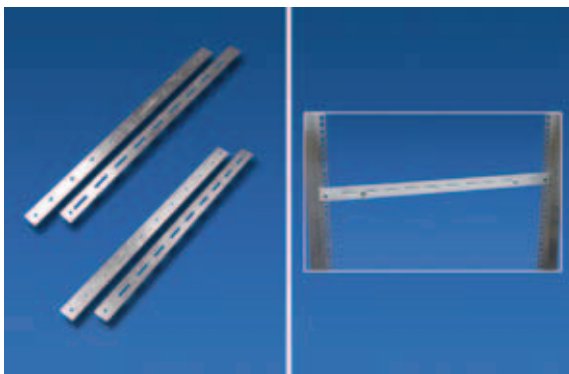

Adjustable pull relief

Variable strip to mount between the first and last 19-inch profiles. The strip stabilises and prevents the 19-inch profiles opening out.

Material: Sheet metal

Finishing: Galvanised

Construction depth

<i>mm</i>	<i>Part. no.</i>
650 - 800	MPR0251

What's in the box: Set of 2, incl. mounting material to mount between the two 19-inch profiles

Varicon M® - Interior

Support spacer 100mm

Spacer for mounting metric profiles in a 800mm wide cabinet. The number of support spacers depends on the number of mounting depth posts.

Material: Sheet metal

Finishing: Galvanised

Width

mm	Part. no.
100	MPR0050

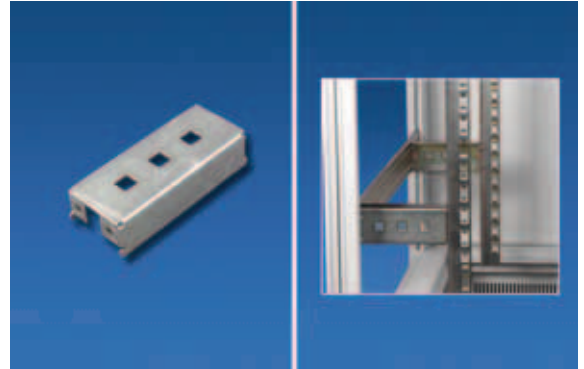

What's in the box: 1 support spacer incl. mounting material

Mounting depth posts

Mounting depth posts can be used to mount metric profiles and/or accessories. For metric profiles, at least 4 posts and 4 support spacers (MPR0050) are necessary.

Material: Sheet metal

Finishing: Galvanised

Depth

mm	Part. no.
600	MPR0150
800	MPR0151
900	MPR0152
1000	MPR0153
1200	MPR0154

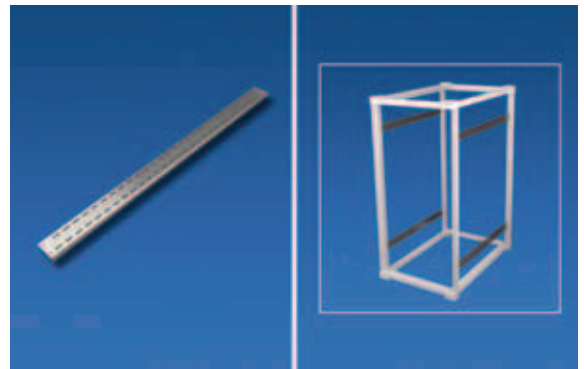

What's in the box: 1 mounting depth post incl. mounting material

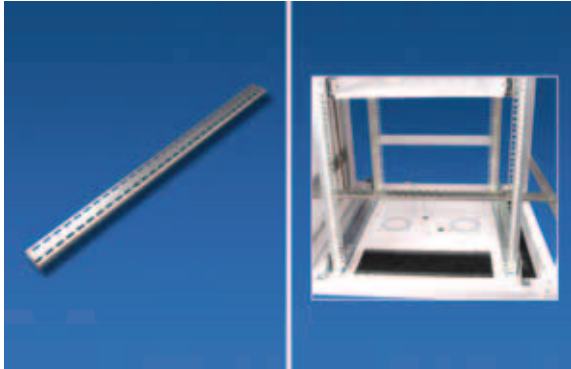
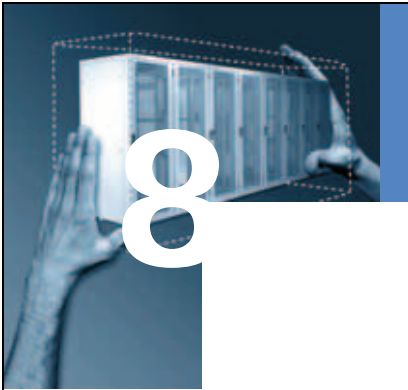

Mounting width posts

By mounting a width post between the mounting depth posts, a horizontal connection can be created for example for cable guidance.

Material: Sheet metal

Finishing: Galvanised

Width

<i>mm</i>	<i>Part. no.</i>
600	MPR0100
800	MPR0101

What's in the box: 1 mounting width post incl. mounting material

Shelves

Mounting materials

Power strip aluminum

Power strip aluminum

Earthing

Cable management

Climate control

Front panel

Document holder

Lighting

TFT drawer system 19-inch



Varicon M® - Accessories

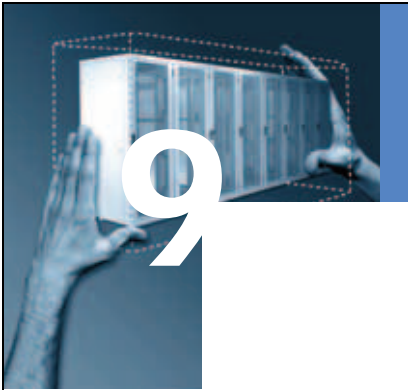

Shelves



Minkels Fix Easy shelves

This shelf has a variable depth, so installation no longer depends on the distance between the 19"-profiles. When developing the shelf, emphasize was put on quick and easy installation, which now takes no time at all. Special plastic clips ensure the shelf is fixated on the 19"-profiles, no tools required!

Weight capacity is based on a maximum rail extension of 150 mm. Shelves with a depth of 650 mm or more will also be available in black RAL 9011.

<i>Depth</i>	<i>Construction depth</i>	<i>Maximum weight</i>	<i>Useable space</i>	<i>Color</i>	<i>Part. no.</i>
<i>mm</i>	<i>mm</i>	<i>kg</i>			
0	0 - 0	0		White	MFE0020
250	250 - 400	50	447 x 250	RAL 7047	MFE0001
350	350 - 500	50	447 x 350	RAL 7047	MFE0002
500	500 - 650	50	447 x 500	RAL 7047	MFE0003
650	650 - 800	40	447 x 650	RAL 7047	MFE0004
650	650 - 800	40	447 x 650	RAL 9011	MFE0004B
800	800 - 950	40	447 x 800	RAL 7047	MFE0005
800	800 - 950	40	447 x 800	RAL 9011	MFE0005B

What's in the box: 1 shelf, 2 guiding rails, 4 fixation clips (an extra set of 4 fixation clips is available, part. no is MFE0020)

Varicon M® - Accessories

Variable shelves

Variable shelf, which means the depth of the shelf does not have to be equal to the distance between the 19-inch profiles. The shelf is attached to the 19-inch profiles. The maximum weight is valid in case of equal weight distribution.

Construction space: 12 mm
 Material: Sheet metal
 Finishing: Powder coated
 Color: RAL 7047

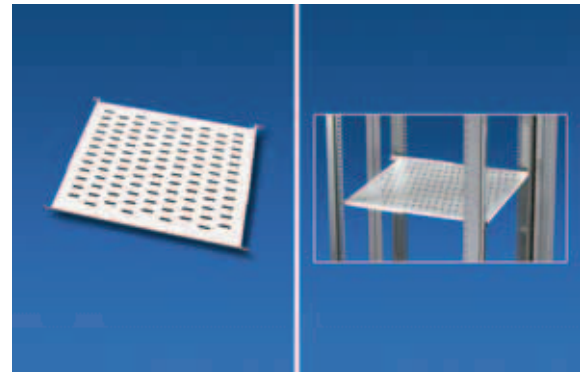

<i>Depth</i> <i>mm</i>	<i>Construction depth</i> <i>mm</i>	<i>Maximum weight</i> <i>kg</i>	<i>Useable space</i>	<i>Part. no.</i>
250	250 - 400	50	447 x 250	MPL0010
350	250 - 500	50	447 X 350	MPL0011
500	400 - 650	50	447 X 500	MPL0012
700	600 - 850	40	447 x 700	MPL0013

What's in the box: 1 shelf, 2 mounting rails, incl. mounting material

Variable shelves 19-inch 100Kg

Maximum perforated variable shelf, with a maximum weight of 100 kilo. Variable means the depth of the shelf does not have to be equal to the distance between the first and last 19-inch profiles. The shelf is attached to the 19-inch profiles. The maximum weight is valid in case of equal weight distribution.

Construction space: 25 mm
 Maximum weight: 100 kg
 Material: Sheet metal
 Finishing: Powder coated

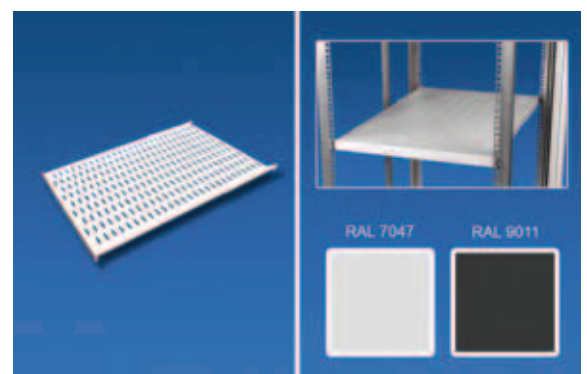

<i>Depth</i> <i>mm</i>	<i>Construction depth</i> <i>mm</i>	<i>Useable space</i>	<i>Color</i>	<i>Part. no.</i>
700	600 - 850	447 x 700	RAL 7047	MPL0014
700	600 - 850	447 x 700	RAL 9011	MPL0014B
800	700 - 950	447 x 800	RAL 7047	MPL0015
800	700 - 950	447 x 800	RAL 9011	MPL0015B

What's in the box: 1 shelf, 2 mounting rails, incl. mounting material

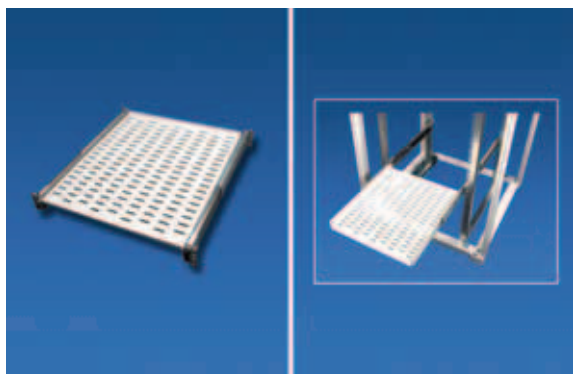
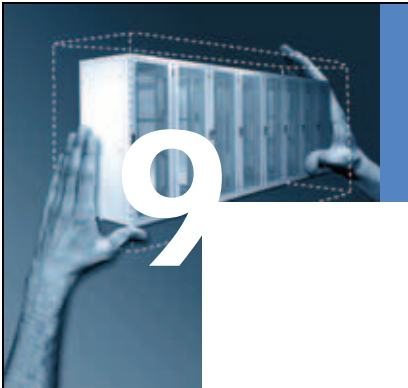

Variable telescopic shelves

A perforated shelf mounted on telescopic rails slides out smoothly, which makes it easy to use. The shelf is attached to the 19-inch profiles. The maximum weight is valid in case of equal weight distribution.

Construction space: 55 mm
 Material: Sheet metal
 Finishing: Powder coated
 Color: RAL 7047

<i>Depth</i> <i>mm</i>	<i>Construction depth</i> <i>mm</i>	<i>Maximum weight</i> <i>kg</i>	<i>Useable space</i>	<i>Retractable length</i> <i>mm</i>	<i>Part. no.</i>
300	150 - 400	75	415 x 300	300	MPL0110
350	350 - 550	75	415 x 350	350	MPL0111
500	400 - 700	75	415 x 500	500	MPL0112
700	600 - 900	50	415 x 700	700	MPL0113

64

What's in the box: 1 telescopic shelf incl. mounting rails and mounting material

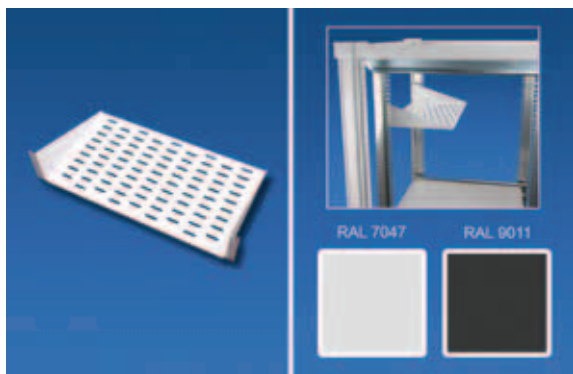

Cantilever shelves

Semi floating perforated shelf of 2 U that can be mounted on the 19 inch profiles. The maximum weight is valid in case of equal weight distribution.

Maximum weight: 12 kg
 Material: Steel
 Finishing: Powder coated

<i>Depth</i> <i>mm</i>	<i>Unit</i> <i>U</i>	<i>Description</i>	<i>Color</i>	<i>Part. no.</i>
250	2	Half floating 2 U	RAL 7047	MPL0311
350	2	Half floating 2 U	RAL 9011	MPL0312B
350	2	Half floating 2 U	RAL 7047	MPL0312

What's in the box: 1 cantilever shelf incl. mounting material

Varicon M® - Accessories

Keyboard shelves 19-inch

Telescopic keyboard shelf is fitted between the 19-inch profiles and can be moved into any required position. Any commercial keyboard can be placed on the keyboard shelf. The maximum weight is valid in case of equal weight distribution.

Construction space: 415 mm

Maximum weight: 50 kg

Material: Sheet metal

Finishing: Powder coated

Useable space: 415 x 500



<i>Depth</i> <i>mm</i>	<i>Construction depth</i> <i>mm</i>	<i>Retractable length</i> <i>mm</i>	<i>Color</i>	<i>Part. no.</i>
500	400 - 700	400	RAL 7047	MPK0001
700	600 - 900	750	RAL 7047	MPK0002
700	600 - 900	750	RAL 9011	MPK0002B

What's in the box: 1 keyboard shelf 19-inch incl. telescopic rail and mounting material

65

Full size shelves

Perforated full size shelf which optimally uses the width and depth of the cabinet. Attached to the height posts or mounting posts. The maximum weight is valid in case of equal weight distribution.

Maximum weight: 75 kg

Description: fixed mounted

Material: Sheet metal

Finishing: Powder coated

Color: RAL 7047

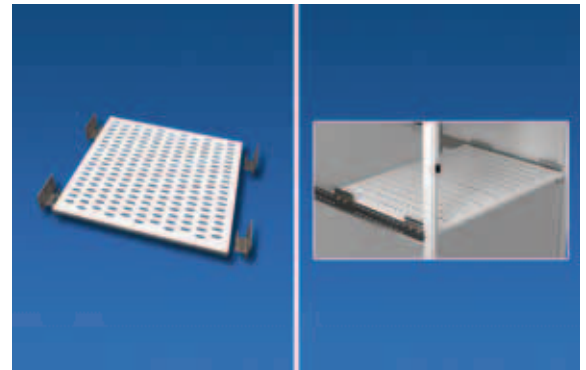

<i>Width</i> <i>mm</i>	<i>Depth</i> <i>mm</i>	<i>Useable space</i>	<i>Part. no.</i>
600	600	530 x 500	MPL0411
600	800	530 x 700	MPL0412
800	600	730 x 500	MPL0511
800	800	730 x 700	MPL0512

What's in the box: 1 shelf, 4 mounting brackets, incl. mounting material

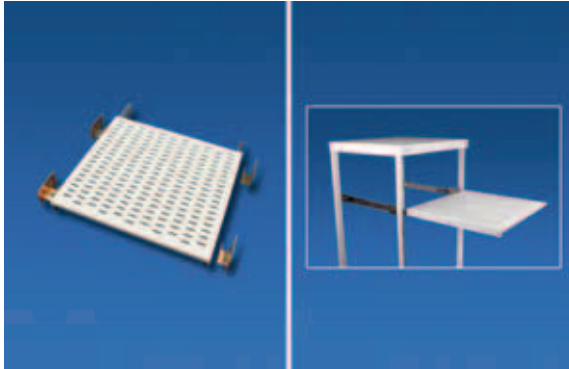

Full size shelves telescopic

Perforated full size shelf which optimally uses the width and depth of the enclosure. Attached to the height posts with telescopic guiding rails for easy installation and maintenance of equipment. The maximum weight is valid in case of equal weight distribution.

Maximum weight: 75 kg
 Description: telescopic
 Material: Sheet metal
 Finishing: Powder coated
 Color: RAL 7047

<i>Width</i> <i>mm</i>	<i>Depth</i> <i>mm</i>	<i>Useable space</i>	<i>Retractable lenght</i> <i>mm</i>	<i>Part. no.</i>
600	600	530 x 500	550	MPL0611
600	800	530 x 700	750	MPL0612
800	600	730 x 500	550	MPL0711
800	800	730 x 700	750	MPL0712

66

What's in the box: 1 shelf, 4 mounting brackets, incl. telescopic guiding rails and mounting material

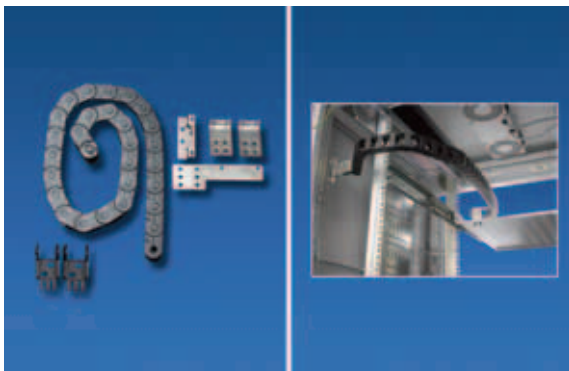

Cable guide for telescopic shelf

Plastic cable guiding of synthetic material for telescopic shelves to avoid damage to the cables during the movement of the shelf.

Retractable lenght

<i>mm</i>	<i>Part. no.</i>
700	MPA0003

What's in the box: 1 cable guide for telescopic shelf, 1 height post bracket, 1 depth post bracket, 1 corner bracket

Varicon M® - Accessories

Stiffener rib for full size shelves

Reinforces the full size shelf and prevents bending of the full size shelves.
The stiffener rib can be added at a later stage if desired.

Description: shelf depth

Depth

<i>mm</i>	<i>Part. no.</i>
500	MPA0010
700	MPA0011



What's in the box: 2x blind rivets

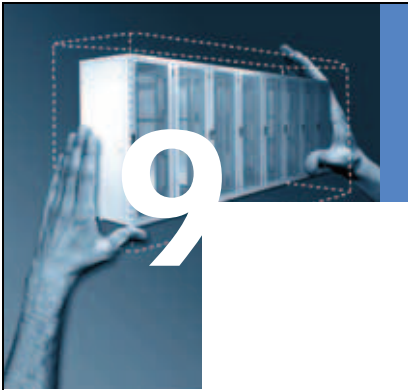

Mounting materials

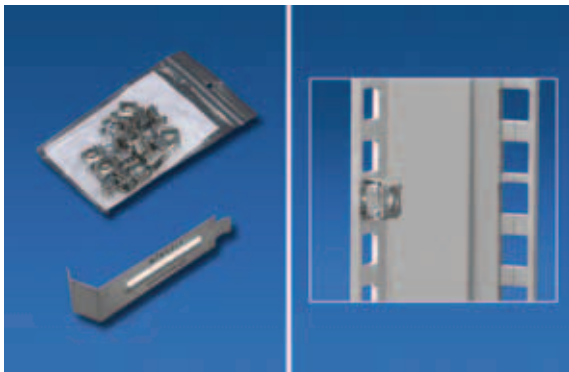

Cage nuts

Caged nuts for mounting applications. They can be mounted in the holes in the front and back of the 19 inch profiles.

Material: Steel

Finishing: Galvanised

68

<i>Diameter</i>	<i>Description</i>	<i>Part. no.</i>
M5	Cage nuts M5 - (20 pieces)	MFM0001
M5	Cage nuts M5 - (100 pieces)	MFM0002
M6	Cage nuts M6 - (20 pieces)	MFM0003
M6	Cage nuts M6 - (100 pieces)	MFM0004

What's in the box: When you order 100 cage nuts you also receive a cage nut mounting tool



Decorative screws with washer

The decorative screws with cross and black plastic ring can be used with cage nuts for mounting at the front and side of the 19-inch profiles.

<i>Diameter</i>	<i>Description</i>	<i>Part. no.</i>
M5 X 16	Decorative screws with washer (black) M5 - (20 pieces)	MFM0010
M5 X 16	Decorative screws with washer (black) M5 - (100 pieces)	MFM0011
M6 X 16	Decorative screws with washer (black) M6 - (20 pieces)	MFM0012
M6 X 16	Decorative screws with washer (black) M6 - (100 pieces)	MFM0013

Varicon M® - Accessories

Third hand

The "third hand" is a nifty tool to support heavy or large equipment during assembly. The "third hand" is temporarily mounted on the 19-inch profiles. By using this tool, the equipment is properly supported.

<i>Description</i>	<i>Part. no.</i>
--------------------	------------------

Mounting tool	MFE0050
---------------	---------

What's in the box: 1 set contains 2 clamps

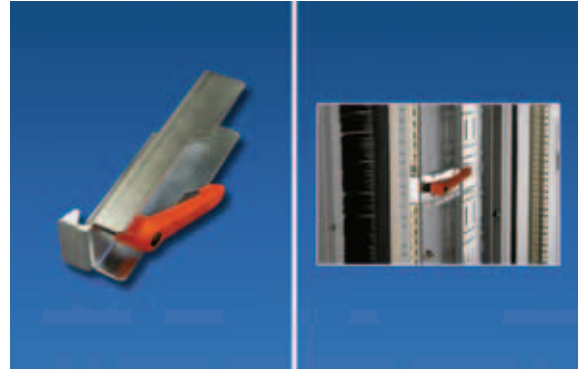

Baying kit

The baying kit is used to connect two cabinets. Different combinations of internal baying bushes and external baying plates are available. The external baying plate can be mounted outside at the height profiles and is invisible when the door is closed. At least 2 connection points should be used in front and back. From 41 HE we advise 3 sets at the front and 3 sets at the back.

Diameter: M4

<i>Description</i>	<i>Color</i>	<i>Part. no.</i>
--------------------	--------------	------------------

Set for internal and external baying	RAL 7047	MFM0050
--------------------------------------	----------	---------

Set for internal and external baying	RAL 9011	MFM0054
--------------------------------------	----------	---------

Baying set external	RAL 7047	MFM0051
---------------------	----------	---------

Baying kit external	RAL 9011	MFM0052
---------------------	----------	---------

Baying kit internal	Blue	MFM0053
---------------------	------	---------

What's in the box: The sets MFM0050 and MFM0054 contain 1 baying bush and 1 baying plate incl. mounting materials. The set MFM0051 and MFM0052 contain 1 baying plate incl. mounting materials. The set MFM0053 contains 1 internal baying bush incl. mounting material



69

Mounting brackets universal (set of 4)

The universal mounting-brackets can, among other things, be used to mount accessories.

<i>Finishing</i>	<i>Part. no.</i>
------------------	------------------

Galvanised	MCE0410
------------	---------

What's in the box: 4 brackets incl. mounting material



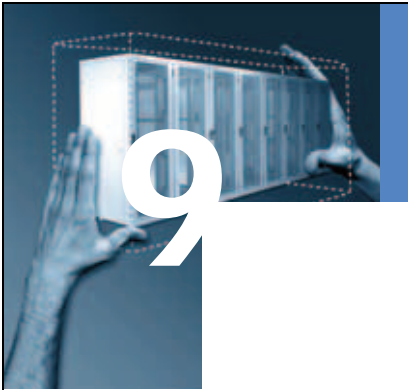

Power strip aluminum

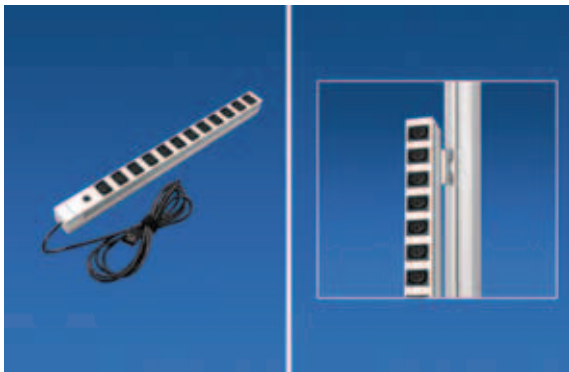

Power strips aluminum IEC-320

The IEC-320 power strip is 10 ampere fused and made of aluminum. 3 Meter cable length with C14 connector is included. The power strips meet the CE standards.

Length

70

# outlets	mm	19-inch	Switch	Technical data	Part. no.
8	438	Yes	-	Cable with C14 connector	MPS5004
8	438	-	-	Cable with C14 connector	MPS5001
12	607	-	-	Cable with C14 connector	MPS5002
16	775	-	-	Cable with C14 connector	MPS5003

What's in the box: 1 power strip, 2 mounting sets, cable length 3m.

Special power strips are available at request



Power strip aluminum

Power strips aluminum

The power strips are made of aluminum and meet the CE standards.

The power strips are approved for 16 ampere.



# outlets	Length		Switch	Technical data	Part. no.
	mm	19-inch			
7	440	Yes	-		MPS4003
13	1250	-	-		MPS4001
19	1810	-	-		MPS4002

What's in the box: 1 power strip, 2 mounting sets, cable length 3m

Mounting set for aluminium power strip

Mounting set for vertical installation of the power strip on the 19-inch profiles.

Part. no.

MPS0097

What's in the box: 1 mounting set incl. mounting material





Earthing



Potential equalising rail

The potential equalising rail is 200mm long, has 1 wire terminal of 25-29mm² and 10 wire terminals of 2,5-25mm² of galvanised sinked steel. The potential equalising rail can be mounted on the depth posts as well as the below window.

length

<i>mm</i>	<i>Part. no.</i>
200	MER0003

What's in the box: 1 rail incl. mounting materials

72



Earth rails copper

The grounding strip (20x5mm) is made from copper and can be fitted to the mounting depth posts, 19-inch profiles and frames vertically.

Material: Copper

Finishing: None

Part. no.

41	MER0106
46	MER0107

What's in the box: 1 rail, 1 wrist band earth point, 1 earthing cable, incl. mounting material and mounting manual

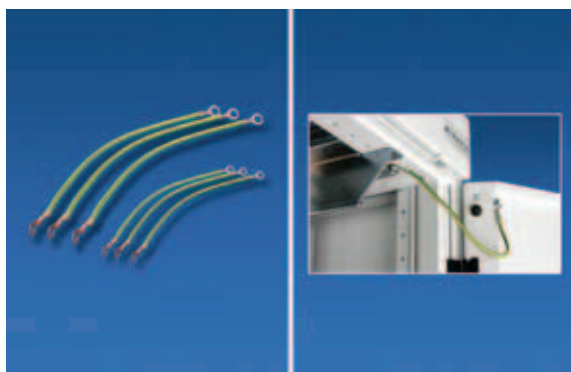

Earthing cables (set)

Set of grounding cables, consisting of 6 grounding cables: 3 x 200mm and 3 x 400mm, supplied with a M-5 lug on both ends for mounting to pre-determined grounding points in the cabinet.

<i>Material</i>	<i>Color</i>	<i>Part. no.</i>
Copper	Yellow/green	MER0001

What's in the box: 3 earthing cables 200mm, 3 earthing cables 400mm, incl. mounting material

Cable management

Shunting eye

The shunting eye can be mounted on 19-inch profiles.

Width: 35 mm

Depth: 64 mm

Description	Part. no.
-------------	-----------

vertical	MCM0001
----------	---------

What's in the box: 1 shunting eye incl. mounting material



Shunting eye

The shunting eye can be mounted on 19-inch profiles.

Width: 30 mm

Depth: 86 mm

Description	Part. no.
-------------	-----------

1 U	MCM0002
-----	---------

What's in the box: 1 shunting eye incl. mounting material



Shunting eye

The shunting eye can be mounted on 19-inch profiles.

Width: 52 mm

Depth: 86 mm

Description	Part. no.
-------------	-----------

1.5 U	MCM0003
-------	---------

What's in the box: 1 shunting eye incl. mounting material





Shunting eye

The shunting eye can be mounted on the 19-inch profiles as well as on the height posts of the frame.

Width: 84 mm

Depth: 86 mm

<i>Description</i>	<i>Part. no.</i>
2 U	MCM0004

What's in the box: 1 shunting eye incl. mounting material

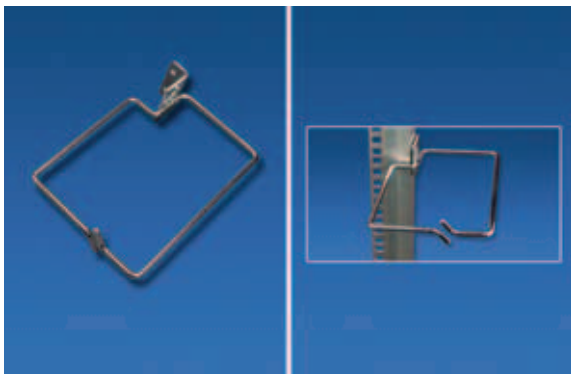

Shunting eye, side mounted

The shunting eye can be mounted on 19-inch profiles.

Width: 110 mm

Depth: 154 mm

<i>Description</i>	<i>Part. no.</i>
mounting on 19-inch	MCM0007

What's in the box: 1 shunting eye incl. mounting material

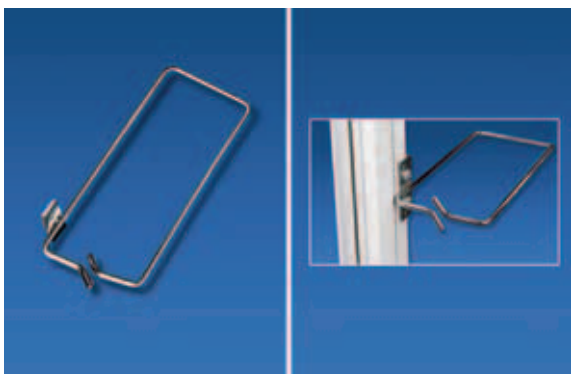

Shunting eye, side mounted

The shunting eye can be mounted on the height posts of the frame.

Width: 85 mm

Depth: 165 mm

<i>Description</i>	<i>Part. no.</i>
mounting on frame post	MCM0008

What's in the box: 1 shunting eye incl. mounting material

Varicon M® - Accessories

Shunting eye, side mounted

The shunting eye can be mounted on the height posts of the frame.

Width: 130 mm

Depth: 120 mm

Description

mounting on frame post

Part. no.

MCM0009

What's in the box: 1 shunting eye incl. mounting material

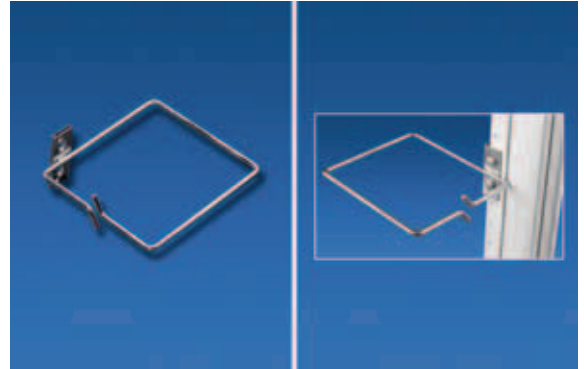

Cable trays, sunked

The cable tray creates various possibilities for vertical cable management in the cabinet. Cables can be attached to the cable tray over the full height of the cabinet. Cable tray is mounted on the top and bottom frame.

Material: Sheet metal

Finishing: Galvanised

Unit

Width

U

mm

Part. no.

25	200	MCM0124
37	200	MCM0125
41	200	MCM0126
41	300	MCM0136
46	200	MCM0127
46	300	MCM0137

What's in the box: 1 cable tray incl. mounting material

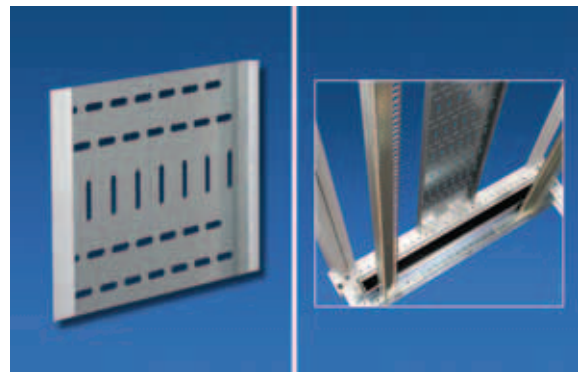

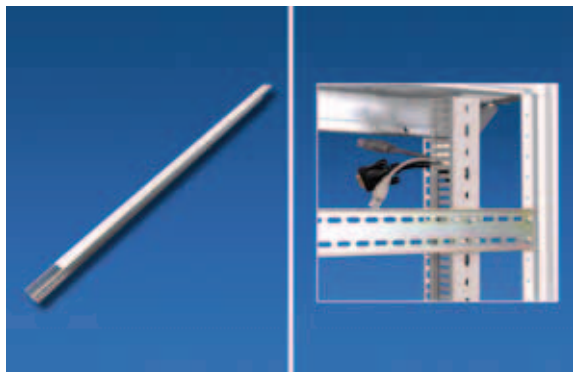

Cable trunks

The cable trunk is made from grey PVC and can be mounted to the depth posts. Trunk contains lid and break-out options on the side for flexibel cable management.

Material: PVC

Color: Grey

<i>Height mm</i>	<i>Width mm</i>	<i>Depth mm</i>	<i>Part. no.</i>
2000	44	45	MCM0050
2000	65	86	MCM0051
2000	65	107	MCM0052
2000	200	65	MCM0053

What's in the box: 1 cable trunk incl. mounting material

76

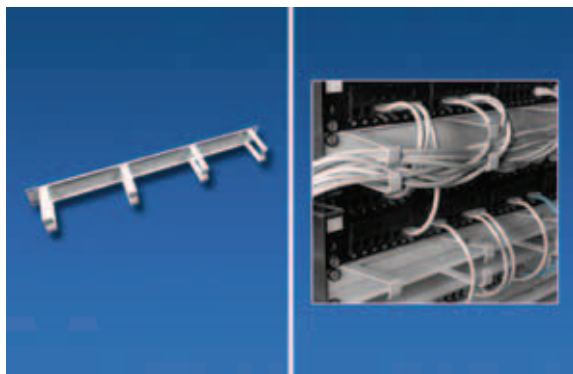

Shunting comb with 4 teeth

The shunting comb allows easy routing of cables.

Material: Sheet metal

Finishing: Powder coated

Color: RAL 7047

<i>Description</i>	<i>Part. no.</i>
With 4 rings, 2 x 1/2 HE x 70 mm	MCM0011

What's in the box: 1 shunting comb incl. mounting material



Velcro tapes

Velcro tapes to bundle cables and for fitting cables on various cable trays quickly and securely.

<i>Part. no.</i>
MCM0100
FDH0420

What's in the box: MCM0100: bundle of 100 pieces, FDH0420: 25 metres velcro, double-sided roll

Varicon M® - Accessories

Cable ties

Cable ties to bundle cables and for fitting cables on various cable trays quickly and securely. Quantity 100.

<i>Width</i> <i>mm</i>	<i>length</i> <i>mm</i>	<i>Part. no.</i>
3	100	MCM0101
5	360	MCM0102

What's in the box: 100 pieces



Cable overlength cassette

Cable overlength cassette for easy and effective cable management.

Material: Sheet metal

Color: RAL 9011

Unit: 2 U

<i>Material</i>	<i>Color</i>	<i>Unit</i> <i>U</i>	<i>Part. no.</i>
Sheet metal	RAL 9011	2	MCM1111

What's in the box: 1 cable overlength cassette incl. mounting material

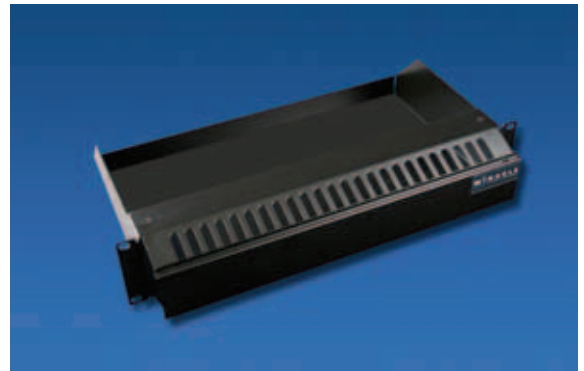



Climate control

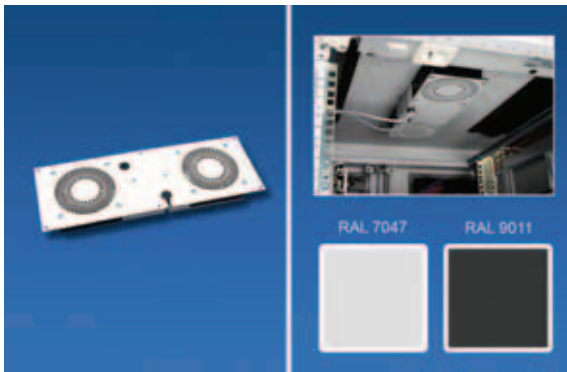

Fan units

The fan unit is supplied with two built-in fans and cables. When mounted in the standard cut out of the base plate it forces the air through the cabinet. When mounted in the standard cut out of the top it draws the air flow out of the cabinet.

78

<i>Description</i>	<i>Technical data</i>	<i>Color</i>	<i>Part. no.</i>
Fan unit including 2 fans and wiring RAL 7047	230VAC - 320m³/h - 44dB - 44Watt	RAL 7047	MBM1007
Fan unit including 2 fans and wiring RAL 9011	230VAC - 320m³/h - 44dB - 44Watt	RAL 9011	MBM1007B

What's in the box: 1 fan unit incl. mounting material



Thermostat

The thermostat measures the heat in the cabinet continuously and switches the fan unit on and off to maintain the desired temperature.

<i>Material</i>	<i>Color</i>	<i>Technical data</i>	<i>Part. no.</i>
Plastic	White	0-60°C, max 6A/250 VAC	MCC0300

What's in the box: 1 thermostat, cable included, 1 mounting bracket, self-adhesive

Front panel

Front panels aluminium, anodized

Front panels are available in different heights to close the open spaces between the 19 inch profiles. This will create an optimise airflow through the installed equipment.

Material: Aluminum

Finishing: Anodised

Thickness: 3.0 mm

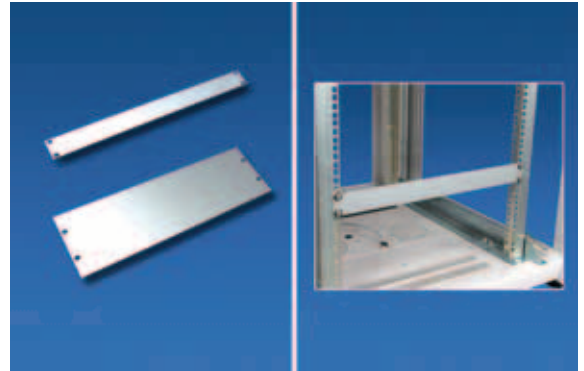

Unit

<i>U</i>	<i>Description</i>	<i>Part. no.</i>
1	Blank front panel	MFA0001
2	Blank front panel	MFA0003
3	Blank front panel	MFA0004
6	Blank front panel	MFA0005
9	Blank front panel	MFA0006
12	Blank front panel	MFA0007

What's in the box: 1 front panel incl. mounting material

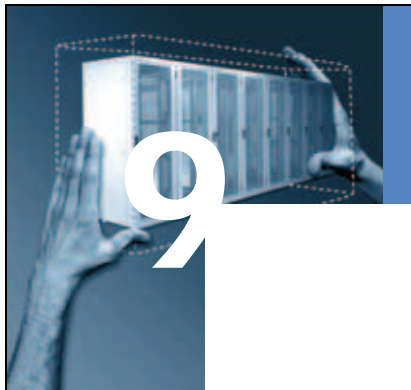

Minkels Fix Easy front panels

When developing the front panel, emphasis was put on quick and easy installation, which now takes no time at all. Special plastic fasteners ensure the front panel is fixated between the 19-inch profiles, no tools required!

The front panels are available in RAL 7047 and RAL 9011. You can order the front panels per set or by the piece.

- Material: Steel
- Thickness: 1.0 mm
- 19-inch: Yes
- Finishing: Powder coated

Unit

<i>U</i>	<i>Description</i>	<i>Color</i>	<i>Part. no.</i>
1	1 piece	RAL 7047	MFE0101
1	1 piece	RAL 9011	MFE0101B
1	Set of 6 pieces	RAL 7047	MFE0111
1	Set of 6 pieces	RAL 9011	MFE0111B
2	1 piece	RAL 7047	MFE0102
2	1 piece	RAL 9011	MFE0102B
2	Set of 6 pieces	RAL 7047	MFE0112
2	Set of 6 pieces	RAL 9011	MFE0112B
3	1 piece	RAL 7047	MFE0103
3	1 piece	RAL 9011	MFE0103B
3	Set of 6 pieces	RAL 7047	MFE0113
3	Set of 6 pieces	RAL 9011	MFE0113B
6	1 piece	RAL 7047	MFE0104
6	1 piece	RAL 9011	MFE0104B
6	Set of 4 pieces	RAL 7047	MFE0114
6	Set of 4 pieces	RAL 9011	MFE0114B
9	1 piece	RAL 7047	MFE0105
9	1 piece	RAL 9011	MFE0105B

What's in the box: 1 front panel incl. plastic fasteners

Document holder

Document holder

The document holder allows documents to be stored in a variety of places in the cabinet. The document holder can easily be mounted by using double sided tape.

Material: Polystyrol

Color: Grey

Part. no.

MDH0001



What's in the box: 1 document holder, self-adhesive



Lighting



Lighting set

The lighting set can be mounted 19-inch as well as on the bottom or top of the frame, without loss of rack space.

<i>Description</i>	<i>Part. no.</i>
19-inch - 600 x 30mm - 14 Watt - 230VAC CE - ENEC - TÜV	MLS0002

What's in the box: 1 lighting set with cable, 1 mounting bracket, incl. mounting material

82



Door switch for lighting set

Door switch for lighting set. Switch can be mounted on the bottom or top frame as well as the height post.

<i>Part. no.</i>
MLS0005

What's in the box: 1 door switch with cable, 1 mounting bracket, incl. mounting material

TFT drawer system 19-inch

TFT monitor drawer system 19-inch

Integrated monitor-keyboard-mouse drawer system for easy and fast installation in server racks. High quality hinges ensure secure positioning of the monitor. Smooth-gliding ball bearing telescoping slides with cable arm. Monitor: 17-inch TFT LCD brilliant display, resolution 1280 x 1024 SXGA, 16.7 mio. colours, on screen menu, PS2 interface for keyboard and touchpad, CE and FCC certified. USB interface in frontpanel. Integrated power supply. The colour of the drawer is RAL 9005. The front panels are RAL 9007.

Unit: 1 U



Unit

<i>U</i>	<i>Description</i>	<i>Keyboard</i>	<i>Part. no.</i>
1	incl. front USB port US layout	qwerty	MTD0001
1	incl. front USB port FR layout	azerty	MTD0002
1	incl. front USB port GE layout	qwertz	MTD0003

What's in the box: 1 TFT monitor drawer system incl. mounting material

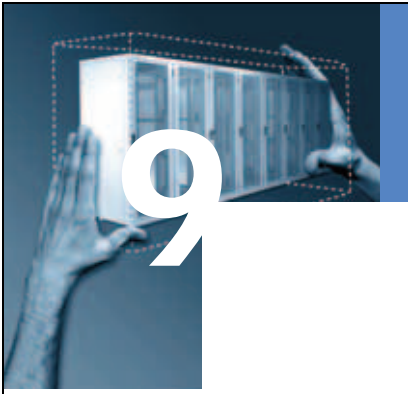

Minkels LANRack

Pre-assembled cabinets

Accessories

Minkels LANRack

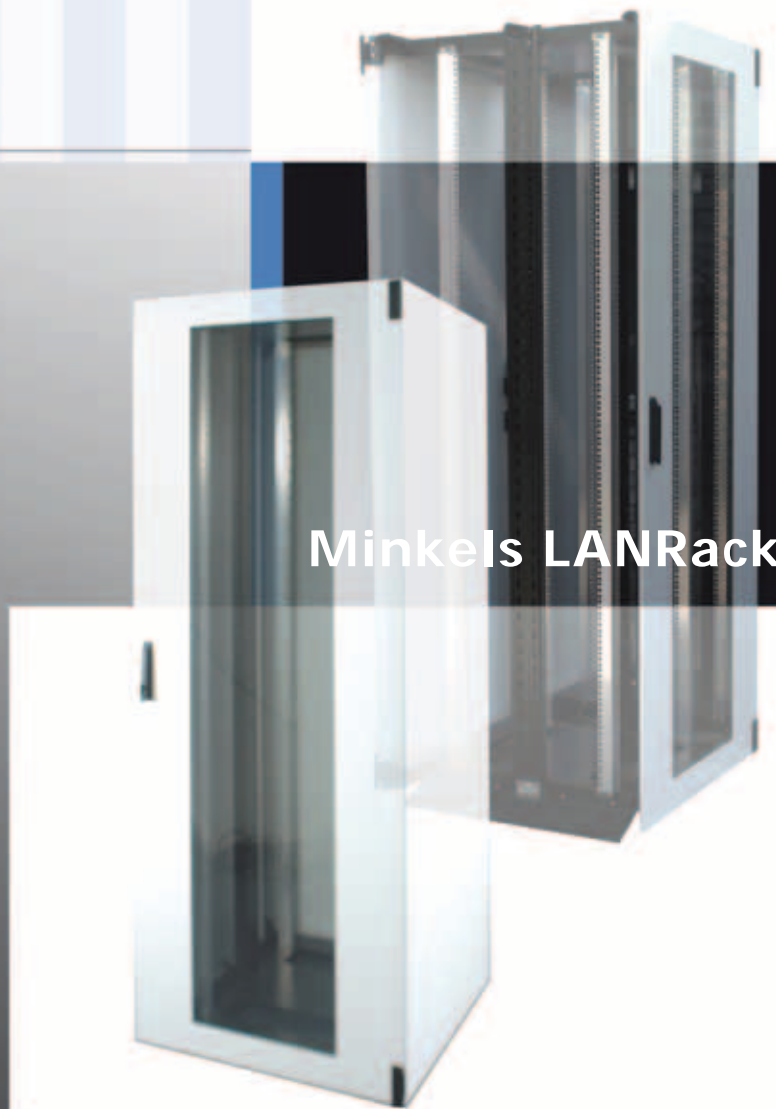

Minkels LANRack



86

The Minkels LANRack is a multifunctional system, specifically designed for ease of installation. The system is ultimately suitable for housing:

- UTP-patch panels
- glass drawers
- telephone panels
- switches and routers
- other IT equipment

Of course it is also possible to include a small number of servers.

Ease of installation

Accessibility is a key feature for the new Minkels LANRack. The basic frame is constructed in such way that the cable bundles can be placed around it. Afterwards the cables can be installed in the rack fast and easy. Finally the doors and side panels can be placed on the frame. These features lead to a considerable reduction in installation time!

Ease of use

For more user comfort, the Minkels LANRack basicframe and the panels are delivered as a handy and compact parcel. Therefore the system can be transported very easily. After the cabling is installed, the panels can be fixed easily by one mechanic. Only a minimal number of tools are required for the assembly.

Portfolio

Various basic configurations result in an optimum solution for each situation. The portfolio exists of open racks which can be bayed, stand-alone racks and baying racks. The Minkels LANRacks can be clustered with the Minkels Varicon M® system also. Besides the basic configurations you can choose from many of our accessories.



Pre-assembled cabinets

Rack - stand alone

The stand alone rack is 800 mm wide, 800 mm deep and 42 HE high. The rack exists of a steel basic frame with leveling feet. Demountable side panels are included. The base & roof have two cut-outs. The rack is provided with four universal 19-inch profiles. The front door contains clear glass, hinges right and is provided with and a swivel handle Fix Easy with blind stop. The back door is blind.



87

<i>Width</i>	<i>Depth</i>	<i>Unit</i>	<i>Description</i>	<i>Part. no.</i>
<i>mm</i>	<i>mm</i>	<i>U</i>		
800	800	42	Stand alone	MLR2111

Baying rack

The baying rack is 800 mm wide, 800 mm deep and 42 HE high. The rack exists of a steel basic frame with leveling feet. Side panels and baying kits are not included but can be ordered separately (side panel MLR3411, baying kit MLR4201). The rack is provided with four universal 19-inch profiles. The base & roof have two cut-outs. The front door contains clear glass, hinges right and is provided with and a swivel handle Fix Easy with blind stop. The back door is blind.



<i>Width</i>	<i>Depth</i>	<i>Unit</i>	<i>Description</i>	<i>Part. no.</i>
<i>mm</i>	<i>mm</i>	<i>U</i>		
800	800	42	Baying rack	MLR1111

10

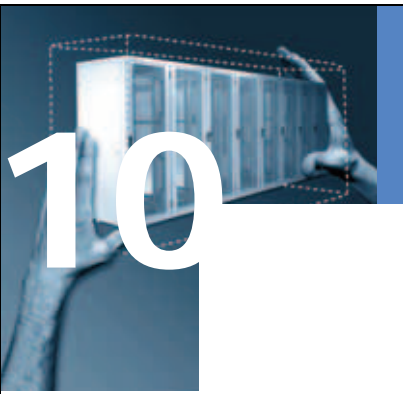

Open frame

The steel basic frame is provided with four 19-inch profiles and will be delivered with leveling feet. The frame is 542 mm wide, 740 mm deep and 42 HE high. The compact frame can easily be moved through each door.

<i>Width</i>	<i>Depth</i>	<i>Unit</i>	<i>Description</i>	<i>Part. no.</i>
<i>mm</i>	<i>mm</i>	<i>U</i>		
542	740	42	Open frame	MLR0111

Accessories

Blind door

Steel door without perforation. The door will be delivered with mounting brackets, hinges and a swivel handle Fix Easy with blind stop.

<i>Unit</i>	<i>Color</i>	<i>Width mm</i>	<i>Part. no.</i>
42	RAL 7047	800	MLR3211

What's in the box: 1 door with hinges, mounting brackets and a swivel handle Fix Easy



Door glass clear

Steel frame with clear safety glass panel. The door will be delivered with mounting brackets, hinges and a swivel handle Fix Easy with blind stop.

<i>Unit</i>	<i>Color</i>	<i>Width mm</i>	<i>Part. no.</i>
42	RAL 7047	800	MLR3311

What's in the box: 1 door with hinges, mounting brackets and a swivel handle Fix Easy



10

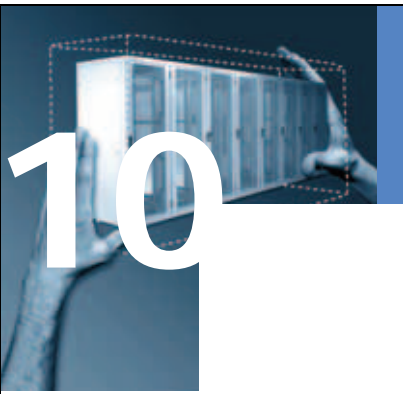

Side panel

The blind side panels are fast and easily removable by means of a square 6 lock. A mounting bracket is included.

<i>Unit</i>	<i>Color</i>	<i>Depth mm</i>	<i>Part. no.</i>
42	RAL 7047	800	MLR3411

What's in the box: 1 panel with square 6 lock and a mounting bracket.

90

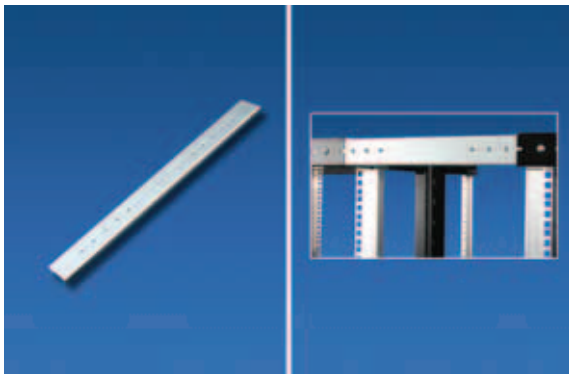

Baying kit

Baying kits are needed to bay racks.

Description

Part. no.

MLR4201 is suitable for baying racks (MLR1111)	MLR4201
MLR4202 is suitable for baying open frames (MLR0111)	MLR4202
MLR4203 is suitable for baying to Varicon M® racks	MLR4203

What's in the box: Baying kit MLR4201 contains 4 baying plates. Baying kit MLR4202 contains 4 strips. Baying kit MLR4203 contains 2 baying plates. All baying kits will be delivered incl. mounting material

Earthing cables (set)

Earthing cables are used for grounding doors and panels.

<i>Material</i>	<i>Color</i>	<i>Part. no.</i>
Copper	Yellow/green	MLR4401

What's in the box: 4 earthing cables 200 mm incl. mounting material

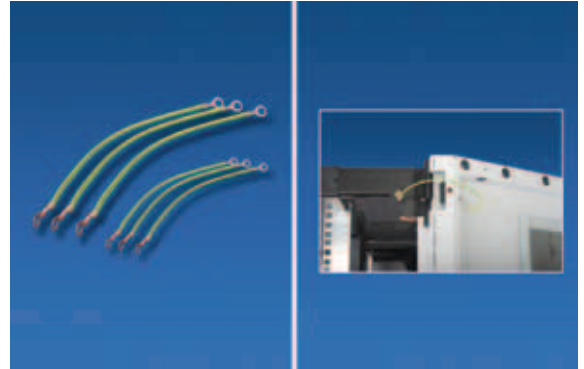

Cover plate

Plate to cover up the bottom or top of the cabinet. The cover plate can be mounted in the base plate or roof.

<i>Description</i>	<i>Technical data</i>	<i>Part. no.</i>
Cover plate RAL 9011	153 x 427 mm	MBM1001B

What's in the box: 1 cover plate incl. mounting material

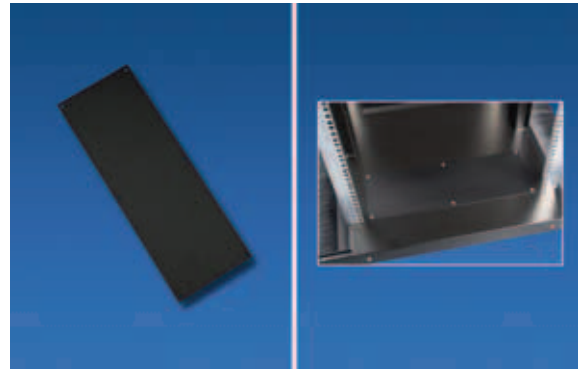

Cable entry brush

Brush for cable entry. The brush can be mounted in the base plate or roof.

<i>Description</i>	<i>Technical data</i>	<i>Part. no.</i>
Set of cable entry brushes	max opening 153 x 427 mm	MBM1003

What's in the box: 1 cable entry brush incl. mounting material

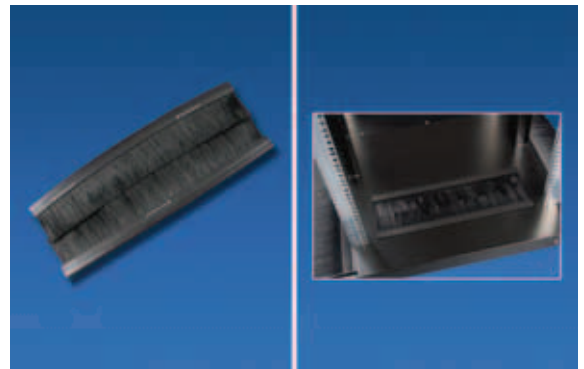

10

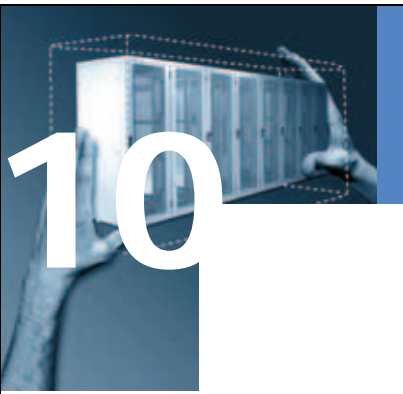

Cable entry brush

Brush for cable entry. The brush will be assembled between the plate/ roof and the side panel.

<i>Description</i>	<i>Technical data</i>	<i>Part. no.</i>
Cable entry brush	800mm deep	MLR4501

What's in the box: 1 cable entry brush incl. mounting material



top

The blind roof can not be used for cable entry and ventilation.

<i>Width</i>	<i>Depth</i>	<i>cut out</i>	<i>Part. no.</i>
<i>mm</i>	<i>mm</i>	<i>pcs</i>	
800	800	0	MLR3111

What's in the box: 1 blind top incl. mounting material



Fan unit incl. 2 fans and wiring RAL 9011

This fan unit is provided with two fans. The fan unit should be fixed in the base/roof plate.

<i>Description</i>	<i>Technical data</i>	<i>Color</i>	<i>Part. no.</i>
Fan unit incl. 2 fans and wiring RAL 9011	230VAC - 320m³/h - 44dB - 44Watt	RAL 9011	MBM1004B

What's in the box: 1 fan unit incl. mounting material

Aluminium power strip SCHUKO

A compact 9-socket aluminum power strip (SCHUKO). The power strip will be delivered with 3 m cable.



# outlets	Length		Switch	Technical data	Part. no.
	mm	19-inch			
9	440	Yes	-		MLR4001

What's in the box: 1 power strip with 3 m cable, incl. mounting material

Aluminium power strip UTE

A compact 9-socket aluminum power strip (UTE). The power strip will be delivered with 3 m cable.



# outlets	Length		Switch	Technical data	Part. no.
	mm	19-inch			
9	440	Yes	-		MLR4021

What's in the box: 1 power strip with 3 m. cable, incl. mounting material

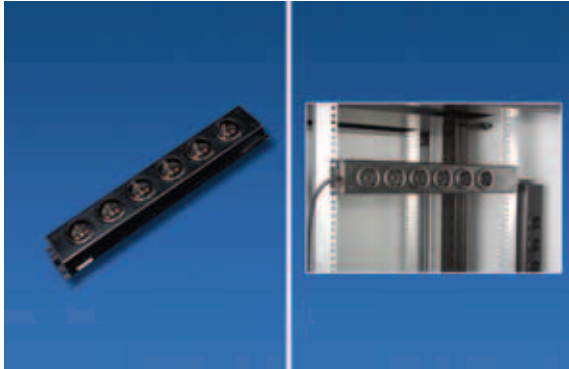
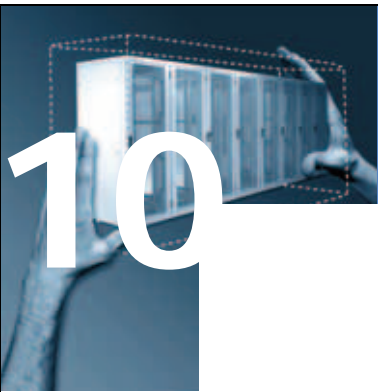

Plastic power strip UTE

A compact 6-socket plastic power strip (UTE). The power strip will be delivered with 3 m cable.

Length

# outlets	mm	19-inch	Switch	Technical data	Part. no.
6	440	Yes	-		MLR4061

What's in the box: 1 power strip with 3 m. cable, incl. mounting material

94



Plastic power strip SCHUKO

A compact 6-socket plastic power strip (SCHUKO). The power strip will be delivered with 3 m cable.

Length

# outlets	mm	19-inch	Switch	Technical data	Part. no.
6	440	Yes	-		MLR4041

What's in the box: 1 power strip with 3 m. cable, incl. mounting material

Shunting eye

The shunting eye for front mounting vertical 35 x 64 mm (w x d) is used for cable management and can be mounted on 19-inch profiles.

Width: 35 mm

Depth: 64 mm

Description	Part. no.
-------------	-----------

vertical	MCM0001
----------	---------

What's in the box: 1 shunting eye incl. mounting material

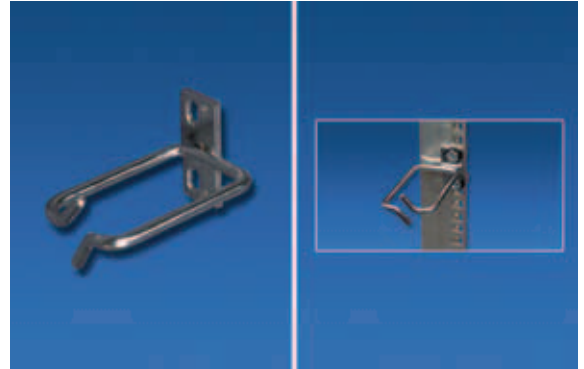

Shunting eye

The shunting eye for front mounting 1HE 30 x 86 mm (w x d) is used for cable management and can be mounted on 19-inch profiles.

Width: 30 mm

Depth: 86 mm

Description	Part. no.
-------------	-----------

1 U	MCM0002
-----	---------

What's in the box: 1 shunting eye incl. mounting material



Shunting eye

The shunting eye for front mounting 1,5HE 52 x 86 mm (w x d) is used for cable management and can be mounted on 19-inch profiles.

Width: 52 mm

Depth: 86 mm

Description	Part. no.
-------------	-----------

1.5 U	MCM0003
-------	---------

What's in the box: 1 shunting eye incl. mounting material

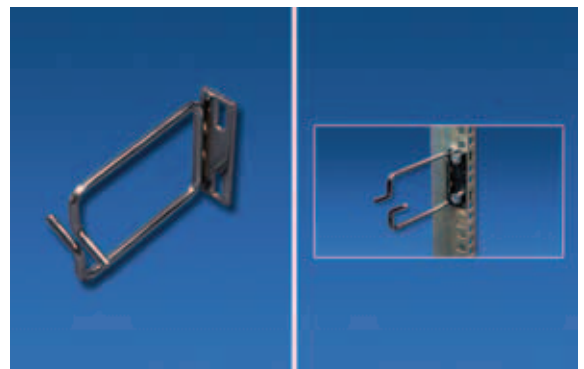

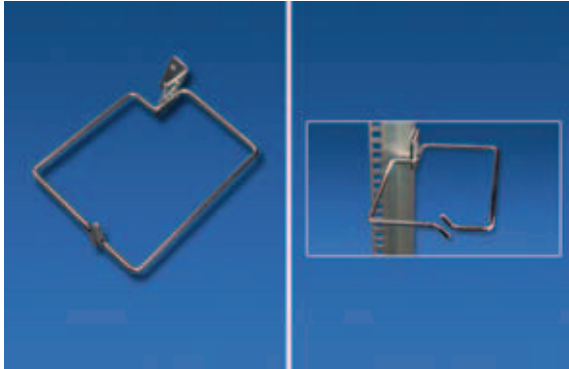
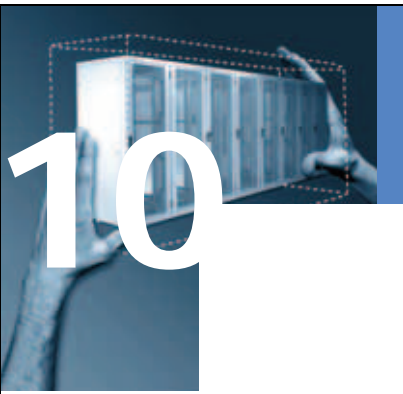

Shunting eye, side mounted

The shunting eye for side mounting 19-inch - 110 x 154mm (w x d) is used for cable management and can be mounted on 19-inch profiles.

Width: 110 mm

Depth: 154 mm

<i>Description</i>	<i>Part. no.</i>
mounting on 19-inch	MCM0007

What's in the box: 1 shunting eye incl. mounting material



Cable tray

Cable trays are used for vertical cable management. The cable tray can be mounted easily to the vertical frame post.

Material: Sheet metal

Finishing: Galvanised

<i>Unit</i>	<i>Width</i>	<i>Part. no.</i>
<i>U</i>	<i>mm</i>	
42	300	MLR4301

What's in the box: 1 cable tray incl. mouning material



Corner guide rail

The corner guide rail supports your network equipment.

<i>Depth</i>	<i>Material</i>	<i>Finishing</i>	<i>Part. no.</i>
<i>mm</i>			
300	Sheet metal	Galvanised	MLR4101

What's in the box: Set of 2 corner guide rails, incl. mounting material

Wall enclosures

MWE

Duopac

Tripac



Wall enclosures



Wall enclosures



The range of wall enclosures includes three progressive concepts: MWE, Duopac and Tripac. Revolutionary housing systems, built from the point of view of flexibility and accessibility.

MWE

The era of labour-intensive installation of your wall enclosure is history! Minkels have introduced a new line of flexible wall enclosures: Minkels Wall-mounted Enclosures (MWE). The wall-enclosures are developed to install and manage inside premises LAN/ICT-network as fast, efficient and tidy as possible. The optimal accessibility is an important aspect for everyone who is involved in installing the network. Important features are the floating construction and the perfect ventilation by means of natural convection through front and rear. Traditionally, wall-enclosures are delivered assembled. However, Minkels Wall-mounted Enclosures are delivered un-assembled. Minkels Wall-mounted-Enclosures are conveniently packed in boxes, which are easy to ship. In the lightweight box, you will find the enclosure and wall fastening. One engineer can very quickly install the enclosure without assistance.



Duopac

Our Duopac Wall enclosure has a compact and elegant design. This slim-line 19-inch enclosure can be used wall-mounted, or as stand-alone. With its limited height, it can be placed on top or under a desk. Thanks to the removable side panels, Duopac is very accessible. Because of this accessibility, the Duopac system is exceptionally suited for housing small networks or decentralised network junctions. With the accessories, Duopac can be easily adapted to suite your needs.

Tripac

The Tripac housing system is a wall enclosure comprising three parts with maximum accessibility, provided by a hinged door, central unit and revolving wall mountings. Tripac is a space-saving system with multifunctionality for e.g. housing network components such as cabling, patch panels, hubs and switches. Tripac is a durable housing system with a competitive price-quality ratio and is available in a variety of sizes. The wide range of accessories allows for further flexibility.

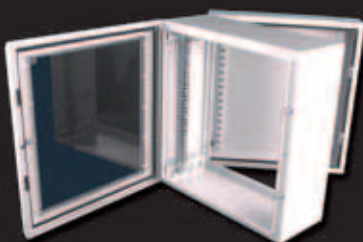

MWE

MWE wall enclosure

The basic frame is built-up of a wall-mounting plate with integrated cable strain, four depth profiles, two cable-entry plates (base and top) and a set of 19-inch profiles. The assembly consists of two equal top and base panels with ventilation slots to the rear, two equal side panels and a safety glass door with a EK-333 cylinder lock with grip.

Color: RAL 7047
 Description: Glass door
 Finishing: Powder coated
 Maximum weight: 100 kg



<i>Unit</i>	<i>Height</i>	<i>Width</i>	<i>Depth</i>	<i>Construction depth</i>	<i>Weight</i>	<i>Part. no.</i>
<i>U</i>	<i>mm</i>	<i>mm</i>	<i>mm</i>	<i>mm</i>	<i>kg</i>	
6	342	600	425	0 - 370	14	MWE06425G
6	342	600	525	0 - 470	16	MWE06525G
9	476	600	425	0 - 370	17	MWE09425G
9	476	600	525	0 - 470	19	MWE09525G
9	476	600	625	0 - 570	21	MWE09625G
12	609	600	425	0 - 370	20	MWE12425G
12	609	600	525	0 - 470	22	MWE12525G
12	609	600	625	0 - 570	24	MWE12625G
15	742	600	525	0 - 470	25	MWE15525G
15	742	600	625	0 - 570	28	MWE15625G
21	1009	600	525	0 - 470	32	MWE21525G
21	1009	600	625	0 - 570	34	MWE21625G

What's in the box: 1 back panel, 4 depth posts, 2 cable entry plates, 2 19" profiles, 2 top and bottom plates, 2 side panels, 1 glass door and 1 assembly set

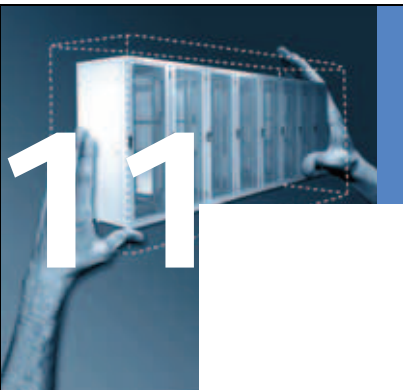

Doors

Optional ventilated metal doors can be used to prevent equipment being on view.

Width: 600 mm
 Material: Sheet metal
 Finishing: Powder coated
 Color: RAL 7047

Width

<i>Unit</i>	<i>600 mm</i>
<i>U</i>	<i>Part. no.</i>
6	MWEMD06
9	MWEMD09
12	MWEMD12
15	MWEMD15
21	MWEMD21

What's in the box: 1 sheet metal door, 1 earthing cable, incl. mounting material



Top plate with fan unit

A fan unit can replace the blank plates in the top of the enclosure to assist cooling.

Material: Sheet metal
 Finishing: Powder coated
 Color: RAL 7047
 Technical data: 230VAC, 60m³/h

Depth

<i>mm</i>	<i>Part. no.</i>
425	MWEFP-425-UK
525	MWEFP-525-UK
625	MWEFP-625-UK

What's in the box: 1 plate with 2 fan-units, incl. mounting material

Thermostate

The thermostat measures the heat in the cabinet continuously and switches the fan unit on and off to maintain the desired temperature.

Material: Plastic

Color: Grey

Technical data: 0-60°C, max 6A/250 VAC



<i>Description</i>	<i>Part. no.</i>
--------------------	------------------

Thermostate	MWETF02
-------------	---------

What's in the box: 1 thermostate, cable included

19-inch profiles

Profiles are used for the assembly of 19-inch components. They are adjustable in depth per 50 mm. It is possible to adjust the entire 19-inch compartment in depth without moving the equipment. Profiles are provided with a pitch of ½ U, to assemble accessories at the side.

Material: Sheet metal

Finishing: Galvanised



Unit

<i>U</i>	<i>Part. no.</i>
----------	------------------

6	MWEPR06
---	---------

9	MWEPR09
---	---------

12	MWEPR12
----	---------

15	MWEPR15
----	---------

21	MWEPR21
----	---------

What's in the box: 2 profiles incl. mounting material

11

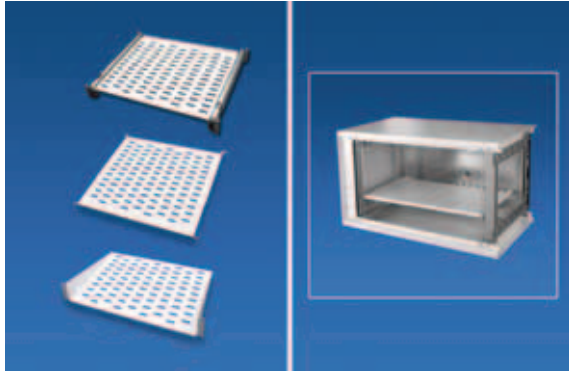
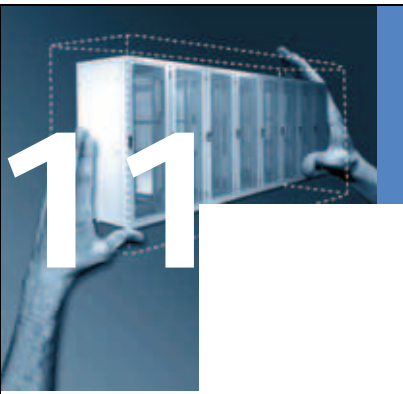

Shelves

Several perforated shelves are available for safe equipment installation. The shelves are attached to the 19-inch profiles. The cantilever types will be mounted to the front (standard) profiles only. The variable and the telescopic shelves have to be attached to the rear side on 19-inch profiles. An additional set of 19-inch profiles are required for the variable and the telescopic shelves.

Material: Sheet metal
 Finishing: Powder coated
 Color: RAL 7047

102

<i>Depth</i> <i>mm</i>	<i>Construction depth</i> <i>mm</i>	<i>Construction space</i> <i>mm</i>	<i>Maximum weight</i> <i>kg</i>	<i>Description</i>	<i>Part. no.</i>
250		89	12	Half floating 2 U	MPL0311
250	250 - 400	12	50	Variable	MPL0010
300	150 - 400	55	75	Telescopic	MPL0110
350		89	12	Half floating 2 U	MPL0312
350	250 - 500	12	50	Variable	MPL0011

What's in the box: 1 shelve incl. mounting material



Shunting eye

The shunting eye for front mounting vertical 35 x 64 mm (w x d) is used for cable management and can be mounted on 19-inch profiles.

Width: 35 mm
 Depth: 64 mm

<i>Description</i>	<i>Part. no.</i>
vertical	MCM0001

What's in the box: 1 shunting eye incl. mounting material

Shunting eye

The shunting eye for front mounting 1HE 30 x 86 mm (w x d) is used for cable management and can be mounted on 19-inch profiles.

Width: 30 mm

Depth: 86 mm

Description	Part. no.
1 U	MCM0002

What's in the box: 1 shunting eye incl. mounting material



Cable ring 19-inch mounted

This cable ring is fitted to the side of the 19-inch profile of your MWE wall enclosure. Because of the specific shape it will fit right in the space between the side and your 19-inch profile. For vertical cable management.

Width: 25 mm

Depth: 111 mm

Description	Part. no.
Vertical side mounting	MWECM01

What's in the box: 1 shunting eye incl. mounting material

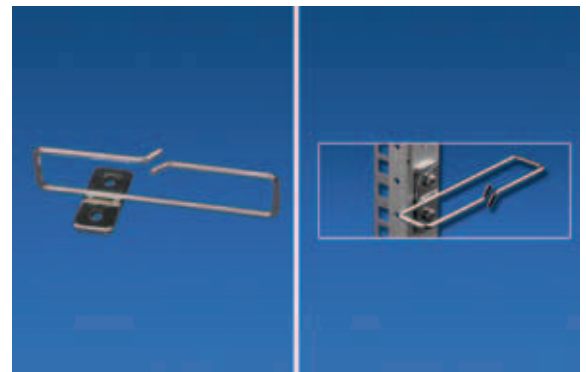

103

Cable entry brush

For dust-proof cable entry, instead of cable entry plates at the top and bottom.

Description	Material	Part. no.
Entry opening 360 mm	Nylon	MWECB01

What's in the box: 1 cable entry brush incl. mounting material



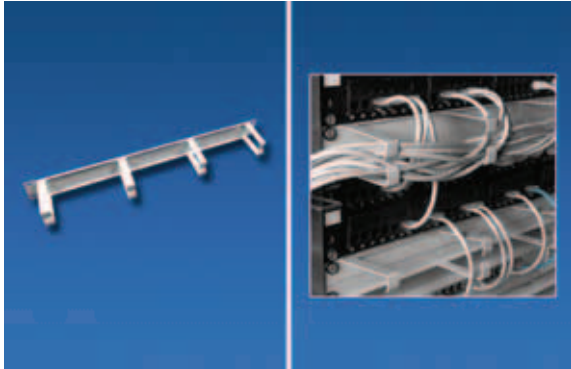
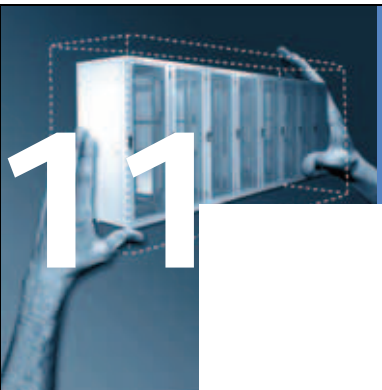

Shunting comb with 4 teeth

The shunting comb allows easy routing of cables.

Material: Sheet metal
 Finishing: Powder coated
 Color: RAL 7047

Description	Part. no.
With 4 rings, 2 x 1/2 HE x 70 mm	MCM0011

What's in the box: 1 shunting comb incl. mounting material



Velcro tapes

Velcro tapes to bundle cables and for fitting cables on various cable trays quickly and securely.

Part. no.
MCM0100
FDH0420

What's in the box: MCM0100: bundle of 100 pieces, FDH0420: 25 metres velcro, double-sided roll

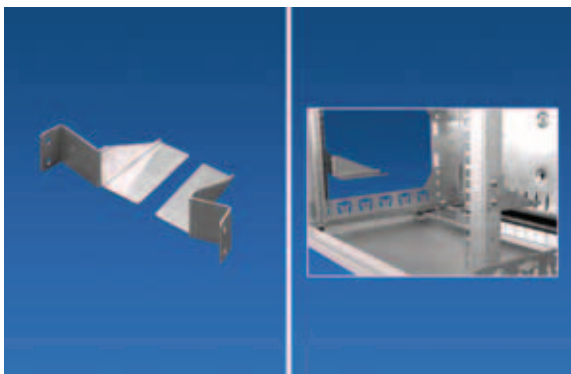

Corner guide rails

The corner guide rail (set of 2) supports heavy 19-inch equipment. They are assembled at the side of the 19-inch profiles, and take up no rack space.

Material: Sheet metal
 Color: Sendzimir

Unit	Maximum weight	Description	Part. no.
U	kg		
1	50	Corner guide rail	MWECS01

What's in the box: 1 corner guide rail left, 1 corner guide rail right, incl. mounting material

Wall enclosures

Mounting material

The screws are designed for the use in your MWE wall enclosure. The kit quantity is for one enclosure.

The plastic click fasteners can be used to assemble a power strip against the rear side. For this you need four fasteners.

Caged nuts for mounting applications. They can be mounted in the holes in the front and back of the 19-inch profiles.

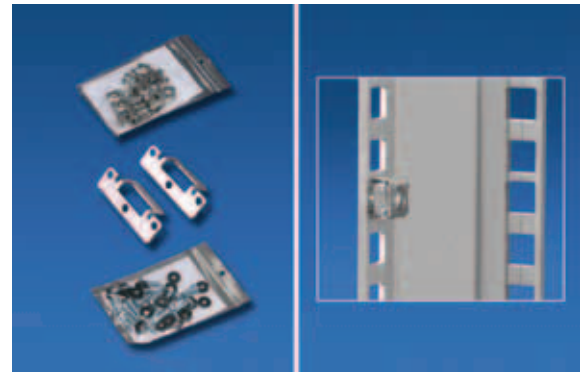

Material	Description	Part. no.
Plastic	Click fasteners for power strip mounting	MWETN01
Plastic	Decorative screws with washer (black) M5 - (20 pieces)	MFM0010
Plastic	Decorative screws with washer (black) M6 - (20 pieces)	MFM0012
Steel	Plate screws - (22 pieces)	MWEXS01
Steel	Cage nuts M5 - (20 pieces)	MFM0001
Steel	Cage nuts M6 - (20 pieces)	MFM0003

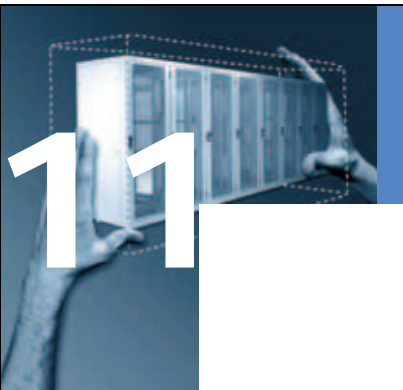

Duopac

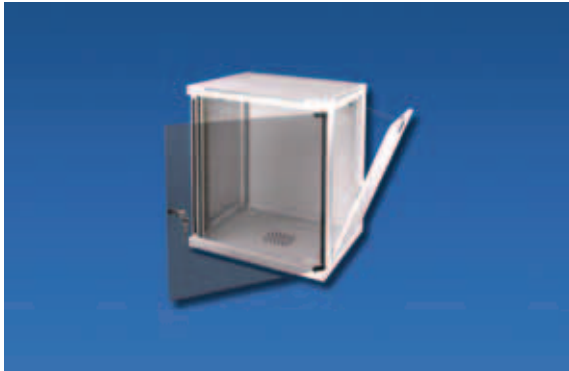

Duopac enclosure

The Duopac is built with one set of 19-inch profiles, mounted in the front part of the enclosure. The enclosure has rubber-damping feet to provide stable and scratch-free standing. The top is ventilated. The quick fit snap locking on the side panels allows easy removal and fitting.

Color: RAL 7047

Description: Door with grey tinted safety glass

Finishing: Powder coated

<i>Unit</i>	<i>Height</i>	<i>Width</i>	<i>Depth</i>	<i>Weight</i>	<i>Part. no.</i>
<i>U</i>	<i>mm</i>	<i>mm</i>	<i>mm</i>	<i>kg</i>	
3	207	530	450	11	DUO.034515
6	343	530	450	14	DUO.064515
9	516	530	450	17	DUO.094515
12	610	530	450	20	DUO.124515
15	745	530	450	23	DUO.154515

What's in the box: complete mounted enclosure with 2 keys



19-inch profiles

Extra profiles can be ordered, among other things for the installation of a server or a shelf. One set consists of two profiles.

Material: Sheet metal

<i>Unit</i>	<i>Part. no.</i>
3	DUO.PR.03.00
6	DUO.PR.06.00
9	DUO.PR.09.00
12	DUO.PR.12.00
15	DUO.PR.15.00

What's in the box: 2 profiles incl. mounting material

Wall enclosures

Shelves

Several perforated shelves are available for safe equipment installation. The shelves are attached to the 19-inch profiles. The cantilever types will be mounted to the front (standard) profiles only. The variable shelves are attached to the rear side on 19-inch profiles as well. An extra set of 19-inch profiles are required for the variable shelves.

Material: Sheet metal

Finishing: Powder coated

Color: RAL 7047

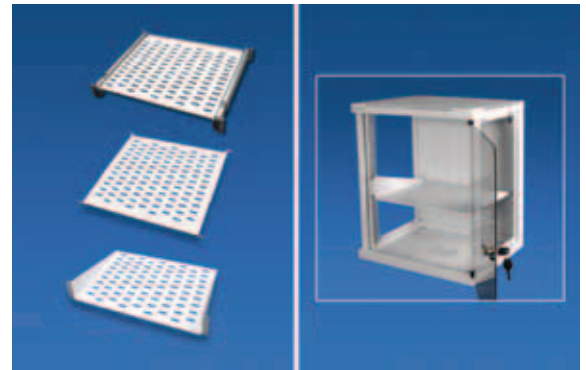

<i>Depth</i> <i>mm</i>	<i>Construction depth</i> <i>mm</i>	<i>Construction space</i> <i>mm</i>	<i>Maximum weight</i> <i>kg</i>	<i>Description</i>	<i>Part. no.</i>
250		89	12	Half floating 2 U	MPL0311
250	250 - 400	12	50	Variable	MPL0010
300	150 - 400	55	75	Telescopic	MPL0110
350		89	12	Half floating 2 U	MPL0312
350	250 - 500	12	50	Variable	MPL0011

What's in the box: 1 shelf incl. mounting materials

107

Adjustable base legs

Adjustable base legs for uneven surfaces.

Material: Plastic



<i>Height</i> <i>mm</i>	<i>Maximum weight</i> <i>kg</i>	<i>Thread length</i> <i>mm</i>	<i>Part. no.</i>
25	850	60	MSM1001

What's in the box: 4 adjustable base legs, incl. mounting material

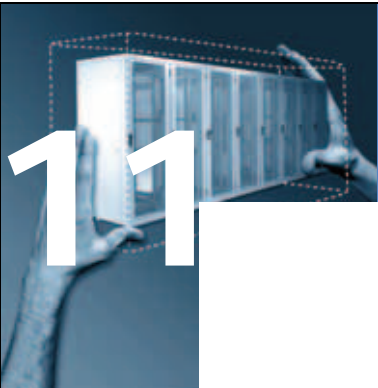

Insert module

It is possible to use the following insert modules in your Duopac or Tripac enclosure. Please note if modules are used, the enclosure will not conform to IP Sealing Specification.

<i>Description</i>	<i>Technical data</i>	<i>Part. no.</i>
Cable entry brushes (set)	Max. entry opening 360 x 50mm	TRI.KA.00.01
Ventilation plate		TRI.VP.00.01

What's in the box: single pieces incl. mounting material

Tripac

Tripac wall enclosure

The Tripac is approved to IP Sealing Specification. The Tripac is available in several sizes, and is provided with a set of 19-inch profiles, and two mounting profiles on the wall mounting plate. The cable can enter from either the top or bottom of the enclosure. A cylinder lock secures the front door. Inside the centre segment the lock can be opened.

Color: RAL 7047

Finishing: Powder coated

Description: Glass door grey tinted



<i>Unit</i>	<i>Height</i>	<i>Width</i>	<i>Depth</i>	<i>Weight</i>	<i>Part. no.</i>
<i>U</i>	<i>mm</i>	<i>mm</i>	<i>mm</i>	<i>kg</i>	
6	345	600	500	22	TRI.065015
9	478	600	500	26	TRI.095015
12	611	600	500	30	TRI.125015
15	744	600	500	34	TRI.155015
18	878	600	500	39	TRI.185015
21	1011	600	500	43	TRI.215015

What's in the box: complete mounted enclosure with 2 keys EK333

109

19-inch profiles

Extra profiles can be ordered, among other things for the installation of a server or a shelf. One set consists of two profiles.

Material: Sheet metal

<i>Unit</i>	<i>Part. no.</i>
<i>U</i>	
6	TRI.PR.06.00
9	TRI.PR.09.00
12	TRI.PR.12.00
15	TRI.PR.15.00
18	TRI.PR.18.00
21	TRI.PR.21.00

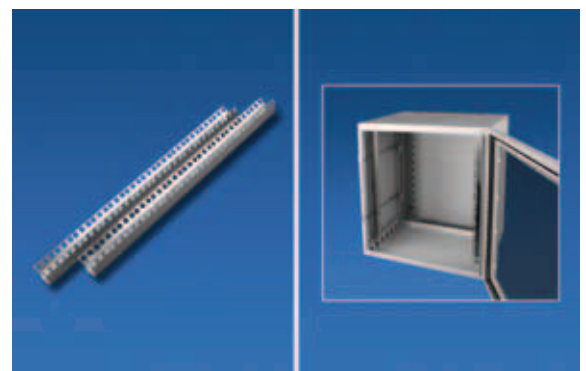

What's in the box: 2 profiles incl. mounting material

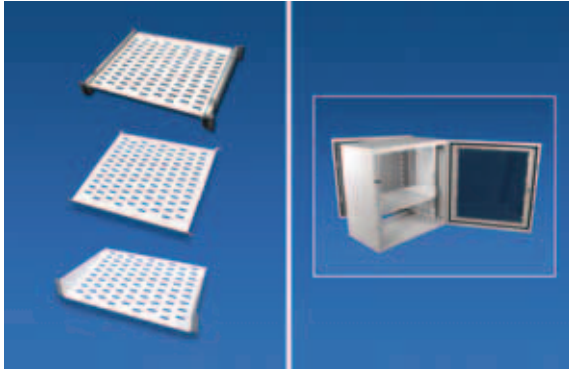
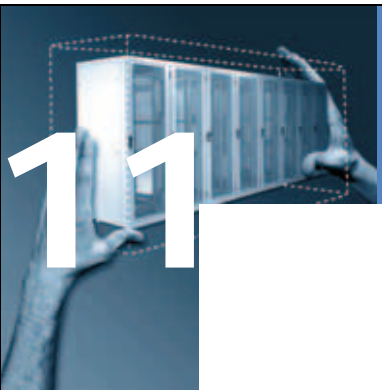

Shelves

Several perforated shelves are available for safe equipment installation. The shelves are attached to the 19-inch profiles. The cantilever types will be mounted at the front (standard) profiles only. The variable shelves have to be attached at the rear side on 19-inch profiles as well. An additional set of 19-inch profiles are required for the variable shelves.

Material: Sheet metal
 Finishing: Powder coated
 Color: RAL 7047

<i>Depth</i> <i>mm</i>	<i>Construction depth</i> <i>mm</i>	<i>Construction space</i> <i>mm</i>	<i>Maximum weight</i> <i>kg</i>	<i>Description</i>	<i>Part. no.</i>
250		89	12	Half floating 2 U	MPL0311
250	250 - 400	12	50	Variable	MPL0010
300	150 - 400	55	75	Telescopic	MPL0110
350		89	12	Half floating 2 U	MPL0312
350	250 - 500	12	50	Variable	MPL0011
350	350 - 550	55	75	Variable telescopic	MPL0111

110

What's in the box: 1 shelfe incl. mounting material



Insert module

It is possible to use the following insert modules in your Duopac or Tripac enclosure. Please note if modules are used, the enclosure will not conform to IP Sealing Specification.

<i>Description</i>	<i>Technical data</i>	<i>Part. no.</i>
Cable entry brushes (set)	Max. entry opening 360 x 50mm	TRI.KA.00.01
Ventilation plate		TRI.VP.00.01

What's in the box: single pieces incl. mounting material

Fan unit

An optional fan unit can be mounted in your Tripac wall enclosure.

<i>Description</i>	<i>Technical data</i>	<i>Part. no.</i>
Fan unit	230VAC / 50 Hz - 110mA - 23 dB - 12 Watt	TRI.VE.00.02

What's in the box: 1 fan unit incl. mounting material



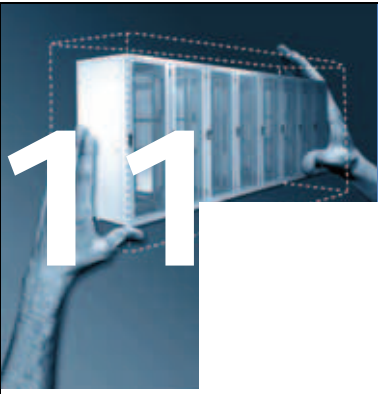

Electronic Locking Solutions

Electronic Locking Solutions



Electronic Locking Solutions



E-Line HID swivel handles

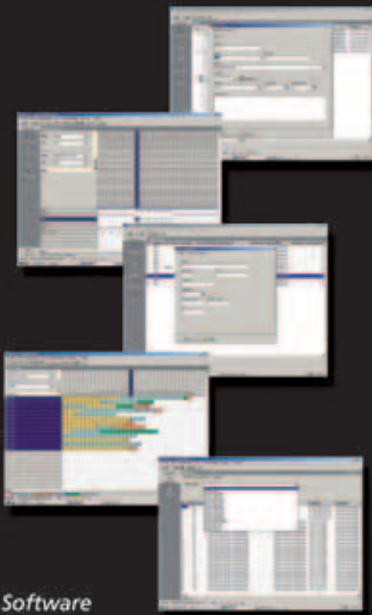

HID Software

To guarantee optimal security, Minkels offers three solutions: E-Line HID-Direct, E-Line HID-485 and E-Line Basic. All solutions are electro mechanical swivel handle systems used for rack access control.

The HID products offer a complete rack access solution. For the authorisation, RFID (Radio Frequency Identification) technology is used. The handles are equipped with a card reader, which is able to read the information from the RFID card. This card contains the authorisation information that is needed to unlock the swivel handle. Management software is supplied with the system and is normally installed on a central server. This software can communicate over the network (Ethernet) with the handles and equipment. The difference between HID-Direct and HID-485 is the communication with the network. The HID-Direct has a direct Ethernet connection. The HID-485 communicates over a serial RS-485 bus, in case an Ethernet network connection is desired, a Gateway is required.

The E-Line Basic swivel handles are equipped with a simple relay-port through which a direct connection with your own application can be easily realised. The main advantage of this system is that in almost every situation it can be integrated with your existing building management or access control system.

The systems fit in all the standard Varicon M® racks, without making any adjustments.

For more information please visit the Minkels website, www.minkels.com.



Fingerprint



Transponder Systems



Your Device



E-Line Basic

Electronic Locking Solutions

Electronic Locking Solutions

Many organisations put a lot of effort in the security of their ICT infrastructure by using building, room, hard- and software security systems. Securing racks should of course be part of the plan.

What if intruders reach your valuable IT-equipment and information? Minkels offers a program of electro mechanical swivel handles which prevent unauthorized entry of your racks: The Minkels E-Line solution.

If you would like information on the E-Line products please download the brochure "Minkels Electronic Locking Solutions".



Description

Part. no.

E-Line HID-Direct swivel handle - 1 point	MEL0010
E-Line HID-Direct swivel handle - 2 points - 41HE	MEL0016
E-Line HID-Direct swivel handle - 2 points - 46HE	MEL0017
E-Line HID-485 swivel handle - 1 point	MEL0020
E-Line HID-485 swivel handle - 2 points - 41HE	MEL0026
E-Line HID-485 swivel handle - 2 points - 46HE	MEL0027
E-Line HID-Direct swivel handle, Fix Easy lock - 2 points - 25U	MEL0032
E-Line HID-Direct swivel handle, Fix Easy lock - 2 points - 41U and 46U	MEL0033
E-Line HID-485 swivel handle, Fix Easy lock - 2 points - 25U	MEL0042
E-Line HID-485 swivel handle, Fix Easy lock - 2 points - 41U and 46U	MEL0043
E-Line Basic swivel handle - 1 point	MEL0050
E-Line Basic swivel handle- 2 points - 41HE	MEL0056
E-Line Basic swivel handle- 2 points - 46HE	MEL0057
E-Line Basic swivel handle, Fix Easy lock - 2 points - 25U	MEL0062
E-Line Basic swivel handle, Fix Easy lock - 2 points - 41 and 46U	MEL0063
E-Line desktop reader	MEL0110
E-Line HID, configurations cable - serial	MEL0111
E-Line Software V3	MEL0112
E-Line HID-485, Gateway V3	MEL0113
E-Line HID-485, Gateway V3 configuration cable	MEL0114
E-Line HID proximity card	MEL0115
E-Line HID adhesive tag	MEL0116

What's in the box: incl. mounting material. **Delivery time to be advised**

12

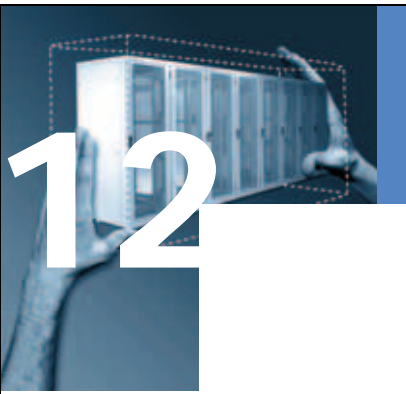

Rack Monitoring System



Rack Monitoring System



Rack Monitoring System

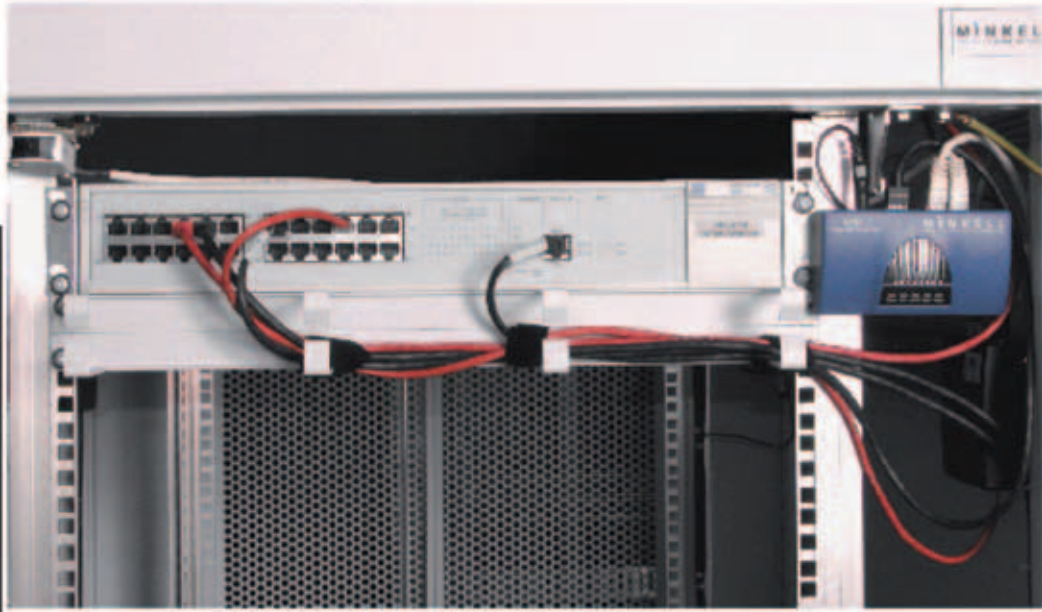

118

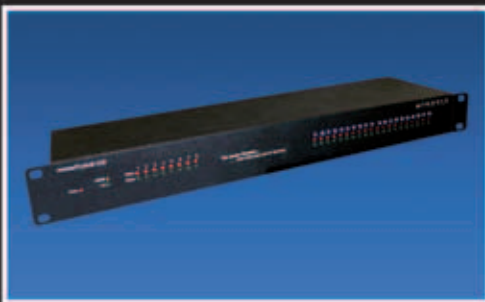

Organisations depend more and more upon the efficiency of their computer systems. The increasing demands being placed on the ICT infrastructure means down time must be kept to an absolute minimum with computer systems operating 100% efficiently 100% of the time. However, even with a good 99% reliability record it still means your system could be down 15 minutes a day or almost four days a year. Fortunately the cost of unwarranted down time can be managed and reduced by using the Minkels rack monitoring system which will give you warning of system and environment failure.

If you would like information on the RMS products please download the brochure "Minkels Rack Monitoring System" on www.minkels.com.

Rack Monitoring System

Rack Monitoring System

The Minkels Rack Monitoring System is able to monitor the direct environment within your cabinet, it can even monitor a complete room.

In case of problems the correct persons can be alarmed in different ways: e-mail, SMS, Web- interface and SNMP. This way Minkels RMS makes sure you don't have to worry about the conditions in your computer; you're in control at all times. Integration with NMS systems such as HP OpenView, WhatsUp Gold and IBM Tivoli is easy to realise

The complete RMS base kit consists of:

- double RMS unit
- power supply
- temperature sensor with 1 meter cable
- installation manual
- installation CD



	<i>Part. no.</i>
RMS Basic kit	MRM0002
RMS 8 port unit - incl. CD and power supply	MRM0010
RMS 8 port unit with 20 dry-contacts - incl. CD and power supply	MRM0020
Intelligent temp. sensor- cable length 1m	MRM0101
Intelligent temp. sensor- cable length 2,5m	MRM0102
Doorswitch - cable length 2.5m	MRM0103
Water sensor - cable length 4.5m	MRM0105
Airflow sensor - cable length 1,5m	MRM0109
Motion detector - cable length 1,5m	MRM0110
Smoke detector - cable length 1,5m	MRM0111
AC-voltage detector - cable length 1,5m	MRM0112
Dry-contact cable - cable length 4,5m	MRM0113
Relais board - cable length 1,5m	MRM0114
DC-volt sensor - cable length 1,5m	MRM0115
4-20mA converter - cable length 1,5m	MRM0116
Double sensor, air humidity and intelligent temperature - RJ-45 connection	MRM0117
Intelligent temp. sensor- RJ-45 connection	MRM0118
Power supply 100/230 VAC, 9VDC 300 mA	MRM0204

What's in the box: incl. mounting material. **Delivery time to be advised**

13

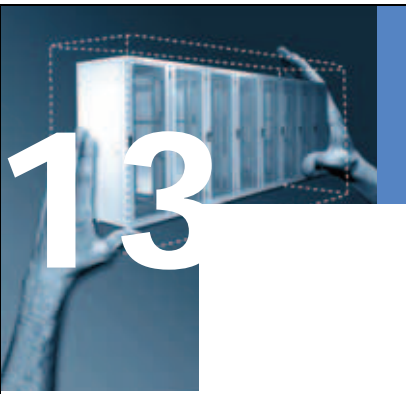

Cooling Solutions



Cooling Solutions

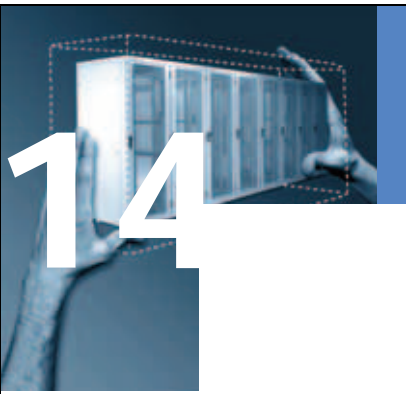

Cooling Solutions



In today's Data Centers, overheating of ICT equipment is one of the most common causes of down time. The cost per minute down time can be tremendous. Minkels offers a range of solutions about how to cool your equipment the right way!

As server density grows, cooling requirements continue to increase. Today's Data Centers can push power requirements to as much as 3000 watts (W) per square meter. A typical 41 U cabinet with servers and storage requires 5 to 8 kilowatts (kW) of load, and high density servers and blades can push this to 12 to 14 kW and higher. It is essential to understand how the Data Center layout can supply these needs. It's not only high-end Data Centers that require good planning: local systems with only a couple of racks also need good planning to avoid critical situations.

Minkels explains all the cooling concepts for Data Centers in the White Paper "Cooling Solutions for Data Centers". In today's rapidly evolving IT environment, facility cooling is becoming ever more important. This paper explains the different solutions for different power requirements and presents an appropriate solution for each situation. This information is clearly presented using the Minkels "Power Cooling Matrix". Using images, diagrams and supportive calculations, help you make the right decisions for your Data Center!



Minkels Power-Cooling Matrix

		Low Density	Low / Medium Density	Medium Density	Medium Density	High Density
Dissipated Power		0-1 kW	1-2 kW	2-4 kW	4-8 kW	8-16 kW
Required airflow $\Delta T < 10^\circ\text{C}$	m ³ /h	0- 310 m ³ /h	310-625 m ³ /h	625-1250 m ³ /h	1250-2500 m ³ /h	2500-5000 m ³ /h
Type 1 Unconditioned office room	a)	Vertical flow with low volume top and bottom fans (110m ³ /h)				
	b)	Horizontal flow with 65% perforated doors	Horizontal flow with 80% perforated doors			
	c)	DX Airco unit attached to the cabinet	DX Airco unit attached to the cabinet			
Type 2 Office room with airconditioning (no raised floor)	a)	Vertical flow with low volume top and bottom fans (110m ³ /h)	Vertical flow with medium volume top and bottom fans (250m ³ /h)			
	b)	Horizontal flow with 65% perforated doors	Horizontal flow with 80% perforated doors			
Type 3 Data Center with airconditioning and raised floor	a)	All solutions possible	Horizontal flow with 80% perforated doors	Horizontal flow with 80% perforated doors		
	b)		Vertical flow with bottom valves and ventilated roof	Vertical flow with air distribution unit and medium volume top fans (1250m ³ /h)	Vertical flow with air distribution unit and medium volume top fans (2500m ³ /h)	
Type 4 Data Center with airconditioning and raised floor, high floor pressure	a)	All solutions possible	Horizontal flow with 65% perforated doors	Horizontal flow with 80% perforated doors		
	b)		Vertical flow with bottom valves and ventilated roof	Vertical flow with bottom valves and medium volume top fans (1250m ³ /h)	Vertical flow with bottom valves and high volume top fans (2500m ³ /h)	Vertical flow with bottom valves and high volume top fans (5000m ³ /h)

123

Low Density Solution

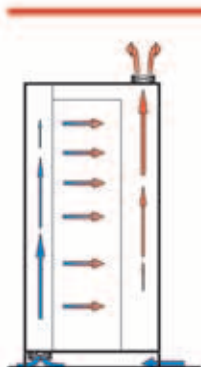
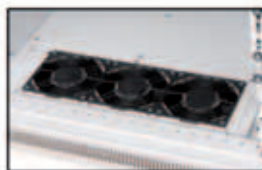
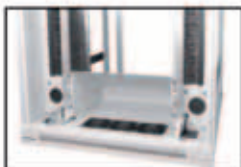

Figure 1



Specifications:

- 1 - 2 kW Cooling capacity
- Prevents air recirculation, saves energy
- Used in combination with or without a raised floor
 - Hot and cold air flows are completely separated
 - Vertical air flow through optimized fan system
- Uniform inlet air temperatur in front of the IT equipment



Heat baffle



Fan unit



Side skirt side panels

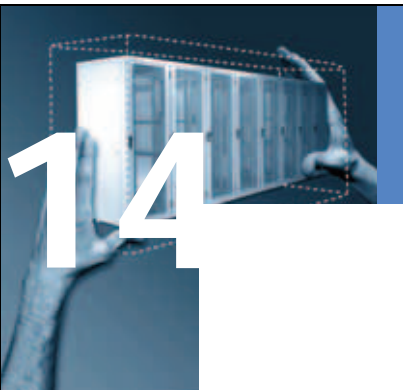

Low / Medium Density Solution - Horizontal Air Flow

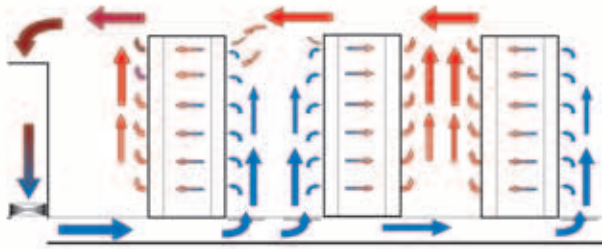

Figure 2

Specifications:

- Up to 4 kW cooling capacity
- Horizontal air flow
- Prevents air recirculation, saves energy
- 80% Perforated doors
- Optimal solution for hot aisle / cold aisle configuration
- Used in combination with a raised floor



124



Side skirts and blanking panels



80% Perforated doors



80% Perforation

Cold corridor cooling concept

Many Data Centers and Computer Rooms use a cold/hot aisle system in which the air is guided to the front of the cabinet through perforated tiles. This air is guided into the cabinet via perforated doors (figure 2). In this traditional situation air recirculation always appears by which the efficiency of the system drops. Minkels offers the possibility to improve this system dramatically by introducing the cold corridor concept. The concept is based on the principle of complete separation of the hot and cold air flow which leads to efficiency improvements. For more information please visit the Minkels website: www.minkels.com.



Wide range of management and security solutions available
 Wide range of cable management solutions available
 Compatible with all standard servers and IT equipment
 Available in RAL 7047 and RAL 9011

Medium Density Solution - Vertical Air Flow

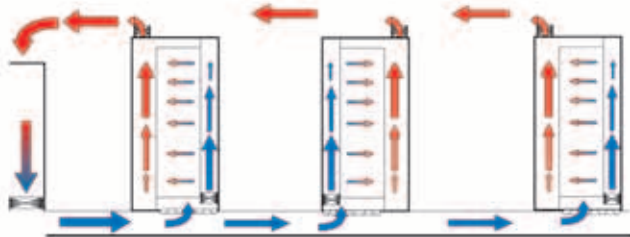

Figure 3

Specifications:

- Up to 8 kW cooling capacity
- Vertical air flow
- Prevents air recirculation, saves energy
- High volume air distribution unit in the bottom
- Medium volume fans in the top, up to 2500 m³/h
- Uniform inlet air temperature in front of the IT equipment
- Used in combination with a raised floor



Air distribution unit



Scalable solution

High Density Solution

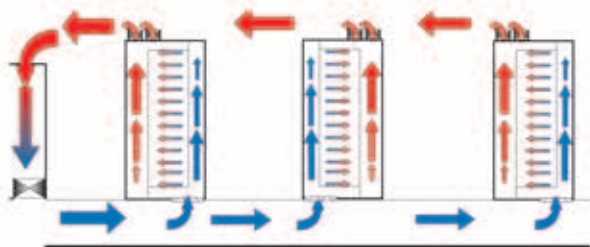

Figure 4

Specifications:

- Up to 16 kW cooling capacity
- Vertical air flow
- Prevents air recirculation, saves energy
- Adjustable air intake valves
- "Hot swappable" fan units
- Scalable between 4 - 16 kW
- Over 5000m³/hr
- Uniform inlet air temperature in front of the equipment
- Used in combination with a raised floor



Scalable solution



"Hot Swappable" fan units



Air intake valves



14

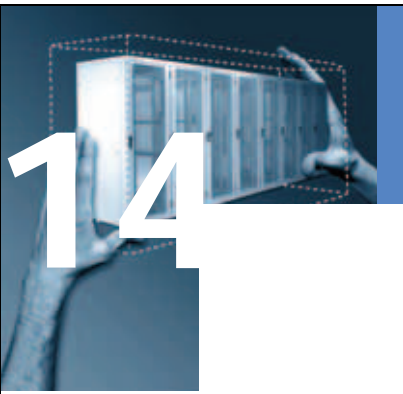

Side skirts

The side skirts are mounted in 800mm wide cabinets next to the 19-inch profiles. They prevent the cold air from leaking along the 19-inch profiles. Each side skirt contains 3 x 2 HE 19-inch cut outs. The cover plates are not included and have to be ordered separately, for example the Minkels Fix Easy front panel MFE0102. Rubber cable grommets are placed at the top and bottom of each side skirt.

Description: Suitable for 800mm wide cabinets

Unit

<i>U</i>	<i>Color</i>	<i>Description</i>	<i>Part. no.</i>
41	RAL 7047	Suitable for 800mm wide cabinets	MCS0006
41	RAL 9011	Suitable for 800mm wide cabinets	MCS0006B
46	RAL 7047	Suitable for 800mm wide cabinets	MCS0007
46	RAL 9011	Suitable for 800mm wide cabinets	MCS0007B

126

What's in the box: One set contains 2 side skirts and 1 top skirt incl. mounting material



Side skirt side panels

The side skirt side panels are used in combination with the side skirts and prevent cold air from leaking to the side of the cabinet. The panels are mounted perpendicular to the side skirts.

Depth: 300 mm

<i>Unit</i>	<i>Depth</i>	<i>Color</i>	<i>Part. no.</i>
<i>U</i>	<i>mm</i>		
41	300	RAL 7047	MCS0016
41	300	RAL 9011	MCS0016B
46	300	RAL 7047	MCS0017
46	300	RAL 9011	MCS0017B

What's in the box: One set contains 2 side skirt side panels incl. mounting material

Side skirt seal kit

The side skirt seal kit is used to seal the gap between the side skirts in case of bayed cabinets. This will prevent cold air from leaking to the back side of the cabinet.

The side skirt seal kit is available in 46 U. In case you would like to use the kit in smaller cabinets, please note that it is possible to cut the kit to the right size.

Unit

U	Material	Color	Part. no.
46	Foam rubber	Bleu	MCS0010

What's in the box: 1 vertical seal strip, 1 horizontal seal strip

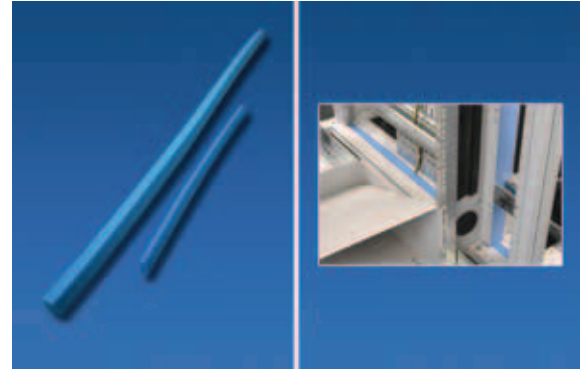

Modular top fan system

The modular top fan system draws hot air from the cabinet. The scalable system is used within the range of 4 and 16 kW. Depending on the cooling requirements the top can be provided with one or more fans, to a maximum of four fans. The fans are mounted in a drawer system and are hot swappable during operation. Depending on your application you can choose between several types of fans, for example not regulated fans or EC-regulated fans. The control unit can also be customised.

For more information, please contact us.



127

Fan-unit IEC with cables

The fan unit contains three axial fans. The maximum flow is 480 m³/h, under normal load this will be over 300m³/h. All connections are of the IEC-320 C13 type. The fan units can be daisy chained using a standard cable with IEC-320 C13 / C14 connectors. All cables are included in the set.

Technical data: Flow under normal load conditions 310 m³/h
Maximum flow 480 m³/h

Color Part. no.

RAL 7047	MCS1007
RAL 9011	MCS1007B

What's in the box: 1 fan unit, 1 power cable, 1 extension cable incl. mounting material



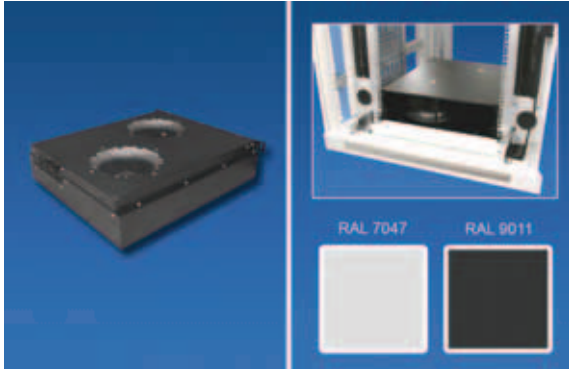

Air distribution unit

The air distribution units are used as local problem solvers in case of hot spots. They are mounted at the bottom of the cabinet between the 19-inch profiles and actively pull cold air from the raised floor, using two or three fans. The power supply is fully redundant and is equipped with two IEC-320 C13 connectors. The fans can also be switched on and off separately.

Technical data

Description

Part. no.

Flow under normal load 1250 m ³ /h	incl. base plate RAL 7047	MCS4001
Flow under normal load 1250 m ³ /h	incl. base plate RAL 9011	MCS4001B
Flow under normal load 2500 m ³ /h	incl. base plate RAL 7047	MCS4002
Flow under normal load 2500 m ³ /h	incl. base plate RAL 9011	MCS4002B
Flow under normal load 1250 m ³ /h	excl. base plate	MCS4010B
Flow under normal load 2500 m ³ /h	excl. base plate	MCS4020B

128

What's in the box: 1 air distribution unit on corner guide rails, 2 power cables. Depending on the set chosen, base plates are included, incl. mounting material



Heat baffle

The heat baffle is used to guide the incoming cold air, which enters from the raised floor, to the front of the cabinet. Therefore, all cold air will be used to cool the equipment and can not leak away. The heat baffle is adjustable in height between 3 and 6 U.

Technical data

Description

Color

Part. no.

Scalable between 1 - 16 kW	Adjustable between 3 - 6 U	RAL 7047	MCS2001
Scalable between 1 - 16 kW	Adjustable between 3 - 6 U	RAL 9011	MCS2001B

What's in the box: 1 heat baffle incl. mounting material

Air intake valves

The mechanical adjustable air intake valves are used to let the air flow into the cabinet from the raised floor. The flow surface is to such a degree dimensioned that the air velocity remains low, even by high air volumes. Therefore, all the air will be used to cool the equipment. The bottom plate is included in this set.



<i>Description</i>	<i>Width mm</i>	<i>Depth mm</i>	<i>Color</i>	<i>Part. no.</i>
Incl. base plate 1000mm	450	450	RAL 7047	MCS3003
Incl. base plate 1000mm	450	450	RAL 9011	MCS3003B
Incl. base plate 1200mm	450	450	RAL 7047	MCS3004
Incl. base plate 1200mm	450	450	RAL 9011	MCS3004B

129

What's in the box: 1 air intake valve, 1 set base plates with 4 cable entry brushes incl. mounting material

Cable entry plate

The cable entry plates are mounted 19-inch in, for example, the side skirts or between the 19-inch profiles and are used for air tight cable entry.

Unit: 2 U



<i>Unit</i>	<i>Color</i>	<i>Part. no.</i>
2	RAL 7047	MCS5002
2	RAL 9011	MCS5002B

What's in the box: 1 cable entry plate incl. mounting material

14

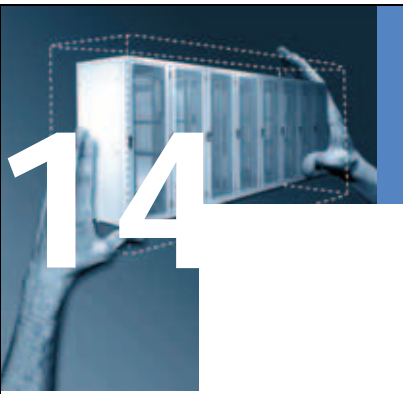

Doors 65% ventilated

Sheet metal door with a 65% perforated surface. The perforation width is equal to the 19-inch standard. The locking mechanism are ordered separately. Hinges are included. Doors are hinged right as standard.

Material: Sheet metal

Finishing: Powder coated

130

<i>Unit</i>	<i>Color</i>	<i>Width mm</i>	
		<i>600</i>	<i>800</i>
<i>U</i>		<i>Part. no.</i>	<i>Part. no.</i>
25	RAL 7047	MFD6014	MFD6114
41	RAL 7047	MFD6016	MFD6116
41	RAL 9011	MFD6016B	MFD6116B
46	RAL 7047	MFD6017	MFD6117
46	RAL 9011	MFD6017B	MFD6117B

What's in the box: 1 door, hinges included (up to and including 25 HE are 2 hinges necessary, over 25 HE are 3 hinges necessary) incl. mounting material

Cooling Solutions

Doors 80% ventilated

The sheet metal door has a maximum perforation surface of 80%. This perforation rate guarantees an optimal air flow. The 600mm wide door has a perforation width of $\pm 445\text{mm}$. The 800mm wide door has a perforation width of $\pm 585\text{mm}$. The locking mechanism are ordered separately. Hinges are included. Doors are hinged right as standard.

Material: Sheet metal

Finishing: Powder coated

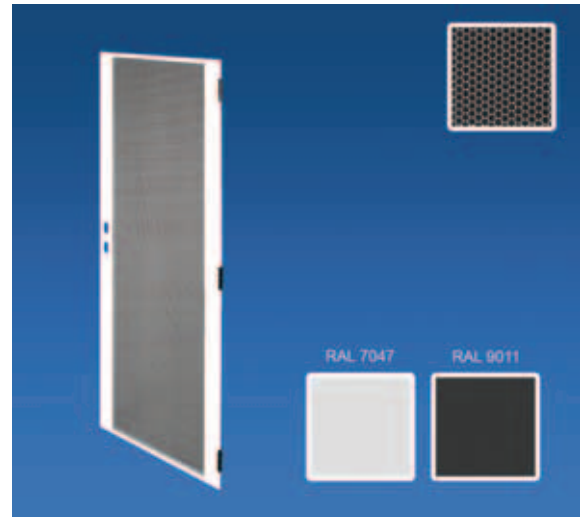

<i>Unit</i>	<i>Color</i>	<i>Width mm</i>	<i>Width mm</i>
		<i>600</i>	<i>800</i>
<i>U</i>		<i>Part. no.</i>	<i>Part. no.</i>
41	RAL 7047	MFD7006	MFD7106
41	RAL 9011	MFD7006B	MFD7106B
46	RAL 7047	MFD7007	MFD7107
46	RAL 9011	MFD7007B	MFD7107B

131

What's in the box: 1 door, hinges included (up to and including 25 HE are 2 hinges necessary, over 25 HE are 3 hinges necessary) incl. mounting material

14

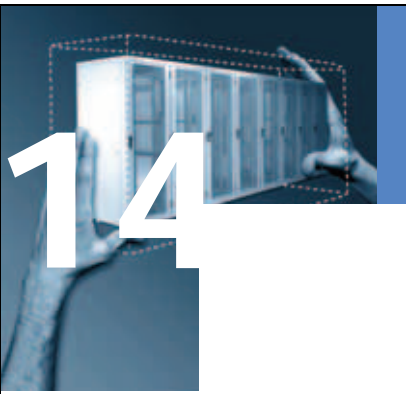

Customised Solutions

A photograph of two business people shaking hands over a desk. The desk has a computer keyboard, a pen, and some papers. The image is partially overlaid with a blue vertical bar and a white horizontal bar.

Customised Solutions

Customised Solutions



Focus on Customers Intimacy
Focus on Customers Intimacy



Minkels has built up a lot of experience in designing, manufacturing and market her own product range. This knowledge and experience is used to advice clients to help provide the right solutions in a cost effective way, both for standard products, as well as highly specialised designs. Minkels offers you the best solutions for products, logistics and services.

Since all competences needed for this process are available within the company, we can help you in the most flexible way. Whenever you want to realise a complete new product, Minkels offers the necessary development and project management capacity. Together with the client, the developers, engineers and project leaders develop a clear specification of the assignment and work in project teams to carry out the project from concept to production and delivery.

Index



Index

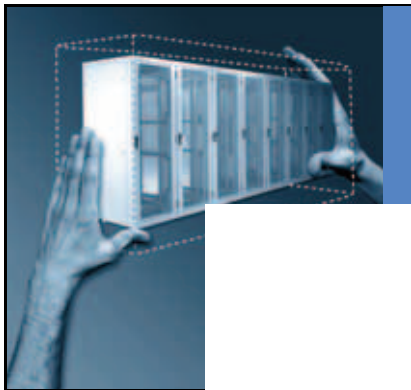

Description	Article no.	Page
A		
Air distribution unit - 1250m ³ /h	MCS4010B	128
Air distribution unit - 1250m ³ /h, incl. bottom plate set RAL 7047	MCS4001	128
Air distribution unit - 1250m ³ /h, incl. bottom plate set RAL 9011	MCS4001B	128
Air distribution unit - 2500m ³ /h	MCS4020B	128
Air distribution unit - 2500m ³ /h, incl. bottom plate set RAL 7047	MCS4002	128
Air distribution unit - 2500m ³ /h, incl. bottom plate set RAL 9011	MCS4002B	128
Air intake valve 450 x 450mm - incl bottom plate set 1000mm RAL 7047	MCS3003	129
Air intake valve 450 x 450mm - incl bottom plate set 1000mm RAL 9011	MCS3003B	129
Air intake valve 450 x 450mm - incl bottom plate set 1200mm RAL 7047	MCS3004	129
Air intake valve 450 x 450mm - incl bottom plate set 1200mm RAL 9011	MCS3004B	129

B		
Base legs, adjustable, set of 4	MSM1001	16, 107
Base legs, extended, set of 4 - 100mm (h)	MSM2001	17
Base plate middle blank - 1000mm (d) RAL 7047	MBM0113	21
Base plate middle blank - 1200mm (d) RAL 7047	MBM0114	21
Base plate middle blank - 600mm (d) RAL 7047	MBM0110	21
Base plate middle blank - 800mm (d) RAL 7047	MBM0111	21
Base plate middle blank - 900mm (d) RAL 7047	MBM0112	21
Base plate middle with 3 cut-outs - 1000mm (d) RAL 7047	MBM0103	21
Base plate middle with 3 cut-outs - 1000mm (d) RAL 9011	MBM0103B	21
Base plate middle with 3 cut-outs - 1200mm (d) RAL 7047	MBM0104	21
Base plate middle with 3 cut-outs - 1200mm (d) RAL 9011	MBM0104B	21
Base plate middle with 3 cut-outs - 600mm (d) RAL 7047	MBM0100	21
Base plate middle with 3 cut-outs - 800mm (d) RAL 7047	MBM0101	21
Base plate middle with 3 cut-outs - 900mm (d) RAL 7047	MBM0102	21
Baying kit MLR external, LANRack-LANRack baying	MLR4201	90
Baying kit MLR external, LANRack-Varicon M® baying	MLR4203	90
Baying kit MLR external, open frame-open frame baying	MLR4202	90
Baying set RAL 7047	MFM0050	69
Baying set RAL 9011	MFM0054	69
Baying set external RAL 7047	MFM0051	69
Baying set external RAL 9011	MFM0052	69
Baying set internal	MFM0053	69
Blank part for base plate - 1000mm (d) RAL 7047	MBM0123	22
Blank part for base plate - 1000mm (d) RAL 9011	MBM0123B	22
Blank part for base plate - 1200mm (d) RAL 7047	MBM0124	22
Blank part for base plate - 1200mm (d) RAL 9011	MBM0124B	22
Blank part for base plate - 600mm (d) RAL 7047	MBM0120	22
Blank part for base plate - 800mm (d) RAL 7047	MBM0121	22
Blank part for base plate - 900mm (d) RAL 7047	MBM0122	22
Blind plate, 1-point lock, square 6mm key	MLK0100	43
Blind plate, 2-points lock Fix Easy, square 6mm key	MLK0511	42
Blind plate, 2-points lock Fix Easy, square 6mm key	MLK0512	42
Blind plate, 2-points lock Fix Easy, square 6mm key	MLK0513	42
Blind plate, 2-points lock, square 6mm key - 25U/45ME (h)	MLK0104	43
Blind plate, 2-points lock, square 6mm key - 37U/65ME (h)	MLK0105	43
Blind plate, 2-points lock, square 6mm key - 41U/73ME (h)	MLK0106	43
Blind plate, 2-points lock, square 6mm key - 46U/81ME (h)	MLK0107	43
Brushes for base plate - 1000mm (d)	MBM0133	22
Brushes for base plate - 1200mm (d)	MBM0134	22
Brushes for base plate - 600mm (d)	MBM0130	22
Brushes for base plate - 800mm (d)	MBM0131	22
Brushes for base plate - 900mm (d)	MBM0132	22

C		
Cabinet, 24h service, pre-ass - 600 x 1000 x 2000mm/41U (w x d x h) RAL 7047	VMC206010C	10
Cabinet, 24h service, pre-ass - 600 x 1000 x 2000mm/41U (w x d x h) RAL 7047	VMC206010S	10
Cabinet, 24h service, pre-ass - 600 x 1000 x 2200mm/46U (w x d x h) RAL 7047	VMC226010C	10
Cabinet, 24h service, pre-ass - 600 x 1000 x 2200mm/46U (w x d x h) RAL 7047	VMC226010S	10
Cabinet, 24h service, pre-ass - 800 x 1000 x 2000mm/41U (w x d x h) RAL 7047	VMC208010C	10

Description	Article no.	Page
Cabinet, 24h service, pre-ass - 800 x 1000 x 2000mm/41U (w x d x h) RAL 7047	VMC208010S	10
Cabinet, 24h service, pre-ass - 800 x 1000 x 2200mm/46U (w x d x h) RAL 7047	VMC228010C	10
Cabinet, 24h service, pre-ass - 800 x 1000 x 2200mm/46U (w x d x h) RAL 7047	VMC228010S	10
Cabinet, 24h service, pre-ass. - 600 x 600 x 1300mm/25U (w x d x h) RAL 7047	VMC136060S	10
Cabinet, 24h service, pre-ass. - 600 x 600 x 2200mm/46U (w x d x h) RAL 7047	VMC226060S	10
Cabinet, 24h service, pre-ass. - 600 x 800 x 1300mm/25U (w x d x h) RAL 7047	VMC136080S	10
Cabinet, 24h service, pre-ass. - 600 x 800 x 2200mm/46U (w x d x h) RAL 7047	VMC226080C	10
Cabinet, 24h service, pre-ass. - 600 x 800 x 2200mm/46U (w x d x h) RAL 7047	VMC226080S	10
Cabinet, 24h service, pre-ass. - 800 x 800 x 1300mm/25U (w x d x h) RAL 7047	VMC138080S	10
Cabinet, 24h service, pre-ass. - 800 x 800 x 2000mm/41U (w x d x h) RAL 7047	VMC208080C	10
Cabinet, 24h service, pre-ass. - 800 x 800 x 2000mm/41U (w x d x h) RAL 7047	VMC208080S	10
Cabinet, 24h service, pre-ass. - 800 x 800 x 2200mm/46U (w x d x h) RAL 7047	VMC228080C	10
Cabinet, 24h service, pre-ass. - 800 x 800 x 2200mm/46U (w x d x h) RAL 7047	VMC228080S	10
Cabinet, co-location 2 sect. pre-ass. - 600 x 1000 x 2200mm/46U (w x d x h)	MCL226010-2N	9
Cabinet, co-location 4 sect. pre-ass. - 600 x 1000 x 2200mm/46U (w x d x h)	MCL226010-4N	9
Cabinet, server, pre-ass. - 600 x 1000 x 2000mm/41U (w x d x h) RAL 9011	VMB416010C	8
Cabinet, server, pre-ass. - 600 x 1000 x 2000mm/41U (w x d x h) RAL 9011	VMB416010S	8
Cabinet, server, pre-ass. - 600 x 1000 x 2200mm/46U (w x d x h) RAL 9011	VMB226010C	8
Cabinet, server, pre-ass. - 600 x 1000 x 2200mm/46U (w x d x h) RAL 9011	VMB226010S	8
Cabinet, server, pre-ass. - 800 x 1000 x 2000mm/41U (w x d x h) RAL 9011	VMB418010C	8
Cabinet, server, pre-ass. - 800 x 1000 x 2000mm/41U (w x d x h) RAL 9011	VMB418010S	8
Cabinet, server, pre-ass. - 800 x 1000 x 2200mm/46U (w x d x h) RAL 9011	VMB228010C	8
Cabinet, server, pre-ass. - 800 x 1000 x 2200mm/46U (w x d x h) RAL 9011	VMB228010S	8
Cable bundle straps (100 pieces) - 2,5 x 100mm (w x l)	MCM0101	77
Cable bundle straps (100 pieces) - 2,5 x 360mm (w x l)	MCM0102	77
Cable entry brush	MBM1003	23, 28, 91
Cable entry brush for base plate - 800mm	MLR4501	92
Cable entry brushes for Duopac and Tripac	TRI.KA.00.01	108, 110
Cable entry plate - 19-inch x 1,5mm x 2U (l x d x h) RAL 7047	MCS5002	129
Cable entry plate - 19-inch x 1,5mm x 2U (l x d x h) RAL 9011	MCS5002B	129
Cable overlength cassette - 19"	MCM1111	77
Cable pull relief for base plate - 600mm (d) RAL 7047	MBM0140	22
Cable pull relief for base plate - 800mm (d) RAL 7047	MBM0141	22
Cable pull relief for base plate - 900/1000mm (d) RAL 7047	MBM0142	22
Cable tray sendzimir MLR - 300mm x 42HE	MLR4301	96
Cable tray sunked - 200mm x 25U (w x h)	MCM0124	75
Cable tray sunked - 200mm x 37U (w x h)	MCM0125	75
Cable tray sunked - 200mm x 41U (w x h)	MCM0126	75
Cable tray sunked - 200mm x 46U (w x h)	MCM0127	75
Cable tray sunked - 300mm x 41U (w x h)	MCM0136	75
Cable tray sunked - 300mm x 46U (w x h)	MCM0137	75
Cable trunk - 200 x 65 x 2000mm (w x d x h)	MCM0053	76
Cable trunk - 44 x 45 x 2000mm (w x d x h)	MCM0050	76
Cable trunk - 65 x 107 x 2000mm (w x d x h)	MCM0052	76
Cable trunk - 65 x 86 x 2000mm (w x d x h)	MCM0051	76
Cage nut M5 - (100 pieces)	MFM0002	68
Cage nut M5 - (20 pieces)	MFM0001	68, 105
Cage nut M6 - (100 pieces)	MFM0004	68
Cage nut M6 - (20 pieces)	MFM0003	68, 105
Castors, set of 2 castors with brakes and 2 castors without brakes	MSM3002	19
Castors, set of 4 castors without brakes	MSM3001	19
Click fasteners for power strip mounting	MWETN01	105
Corner guide rails 1U (set) - build-in 300 - 450mm	MPR0311	58
Corner guide rails 1U (set) - build-in 450 - 750mm	MPR0312	58
Corner guide rails 1U (set) - build-in 740 - 1050mm	MPR0313	58
Corner guide rails MLR 1 HE, 2 pieces - 300mm	MLR4101	96
Cover plate RAL 7047	MBM1001	23, 28
Cover plate RAL 9011	MBM1001B	23, 28, 91
Cylinder lock	MSP0199	45, 51
Cylinder, 1-point lock	MLK0200	43
Cylinder, 2-points Fix Easy lock	MLK0521	42
Cylinder, 2-points Fix Easy lock	MLK0522	42

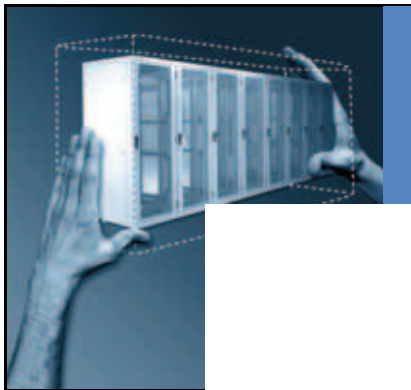

Description	Article no.	Page
Cylinder, 2-points Fix Easy lock	MLK0523	42
Cylinder, 2-points lock - 25U/45ME (h)	MLK0204	43
Cylinder, 2-points lock - 37U/65ME (h)	MLK0205	43
Cylinder, 2-points lock - 41U/73ME (h)	MLK0206	43
Cylinder, 2-points lock - 46U/81ME (h)	MLK0207	43

D

Depth post for divided 19-inch - 600 x 1000mm (w x d)	MPR0173	57
Depth post for divided 19-inch - 600 x 1200mm (w x d)	MPR1174	56
Depth post for divided 19-inch - 600 x 600mm (w x d)	MPR0170	57
Depth post for divided 19-inch - 600 x 800mm (w x d)	MPR0171	57
Depth post for divided 19-inch - 600 x 900mm (w x d)	MPR0172	57
Depth post for divided 19-inch - 800 x 1000mm (w x d)	MPR1173	56
Depth post for divided 19-inch - 800 x 600mm (w x d)	MPR1170	56
Depth post for divided 19-inch - 800 x 800mm (w x d)	MPR1171	56
Depth post for divided 19-inch - 800 x 900mm (w x d)	MPR1172	56
Depth post frame for 19-inch profiles - 1000mm (d)	MPR0163	56
Depth post frame for 19-inch profiles - 1200mm (d)	MPR0164	56
Depth post frame for 19-inch profiles - 600mm (d)	MPR0160	56
Depth post frame for 19-inch profiles - 800mm (d)	MPR0161	56
Depth post frame for 19-inch profiles - 900mm (d)	MPR0162	56
Document holder, A4-size, installation space 30mm	MDH0001	81
Door MLR, single, blind - 800 x 42HE (w x h)	MLR3311	89
Door MLR, single, glass - 800 x 42HE (w x h)	MLR3211	89
Door seal, rubber - 12U/21ME	MFR0001	41
Door seal, rubber - 16U/29ME	MFR0002	41
Door seal, rubber - 21U/37ME	MFR0003	41
Door seal, rubber - 25U/45ME	MFR0004	41
Door seal, rubber - 37U/65ME	MFR0005	41
Door seal, rubber - 41U/73ME	MFR0006	41
Door seal, rubber - 46U/81ME	MFR0007	41
Door switch	MLS0005	82
Door, 65% ventilated - 600mm x 25U/45ME (w x h) RAL 7047	MFD6014	31, 130
Door, 65% ventilated - 600mm x 41U/73ME (w x h) RAL 7047	MFD6016	31, 130
Door, 65% ventilated - 600mm x 41U/73ME (w x h) RAL 9011	MFD6016B	31, 130
Door, 65% ventilated - 600mm x 46U/81ME (w x h) RAL 7047	MFD6017	31, 130
Door, 65% ventilated - 600mm x 46U/81ME (w x h) RAL 9011	MFD6017B	31, 130
Door, 65% ventilated - 800mm x 25U/45ME (w x h) RAL 7047	MFD6114	31, 130
Door, 65% ventilated - 800mm x 41U/73ME (w x h) RAL 7047	MFD6116	31, 130
Door, 65% ventilated - 800mm x 41U/73ME (w x h) RAL 9011	MFD6116B	31, 130
Door, 65% ventilated - 800mm x 46U/81ME (w x h) RAL 7047	MFD6117	31, 130
Door, 65% ventilated - 800mm x 46U/81ME (w x h) RAL 9011	MFD6117B	31, 130
Door, 80% ventilated - 600mm x 41U/73ME (w x h) RAL 7047	MFD7006	32, 131
Door, 80% ventilated - 600mm x 41U/73ME (w x h) RAL 9011	MFD7006B	32, 131
Door, 80% ventilated - 600mm x 46U/81ME (w x h) RAL 7047	MFD7007	32, 131
Door, 80% ventilated - 600mm x 46U/81ME (w x h) RAL 9011	MFD7007B	32, 131
Door, 80% ventilated - 800mm x 41U/73ME (w x h) RAL 7047	MFD7106	32, 131
Door, 80% ventilated - 800mm x 41U/73ME (w x h) RAL 9011	MFD7106B	32, 131
Door, 80% ventilated - 800mm x 46U/81ME (w x h) RAL 7047	MFD7107	32, 131
Door, 80% ventilated - 800mm x 46U/81ME (w x h) RAL 9011	MFD7107B	32, 131
Door, blank - 600mm x 12U/21ME (w x h) RAL 7047	MFD0001	30
Door, blank - 600mm x 16U/29ME (w x h) RAL 7047	MFD0002	30
Door, blank - 600mm x 21U/37ME (w x h) RAL 7047	MFD0003	30
Door, blank - 600mm x 25U/45ME (w x h) RAL 7047	MFD0004	30
Door, blank - 600mm x 37U/65ME (w x h) RAL 7047	MFD0005	30
Door, blank - 600mm x 41U/73ME (w x h) RAL 7047	MFD0006	30
Door, blank - 600mm x 41U/73ME (w x h) RAL 9011	MFD0006B	30
Door, blank - 600mm x 46U/81ME (w x h) RAL 7047	MFD0007	30
Door, blank - 600mm x 46U/81ME (w x h) RAL 9011	MFD0007B	30
Door, blank - 800mm x 25U/45ME (w x h) RAL 7047	MFD0104	30
Door, blank - 800mm x 37U/65ME (w x h) RAL 7047	MFD0105	30
Door, blank - 800mm x 41U/73ME (w x h) RAL 7047	MFD0106	30
Door, blank - 800mm x 41U/73ME (w x h) RAL 9011	MFD0106B	30

Description	Article no.	Page
Door, blank - 800mm x 46U/81ME (w x h) RAL 7047	MFD0107	30
Door, blank - 800mm x 46U/81ME (w x h) RAL 9011	MFD0107B	30
Door, double, 65% ventilated - 600mm x 41U/73ME (w x h) RAL 7047	MDD3016	37
Door, double, 65% ventilated - 600mm x 41U/73ME (w x h) RAL 9011	MDD3016B	37
Door, double, 65% ventilated - 600mm x 46U/81ME (w x h) RAL 7047	MDD3017	37
Door, double, 65% ventilated - 600mm x 46U/81ME (w x h) RAL 9011	MDD3017B	37
Door, double, 65% ventilated - 800mm x 41U/73ME (w x h) RAL 7047	MDD3116	37
Door, double, 65% ventilated - 800mm x 41U/73ME (w x h) RAL 9011	MDD3116B	37
Door, double, 65% ventilated - 800mm x 46U/81ME (w x h) RAL 7047	MDD3117	37
Door, double, 65% ventilated - 800mm x 46U/81ME (w x h) RAL 9011	MDD3117B	37
Door, double, 80% ventilated - 600mm x 41U/73ME (w x h) RAL 7047	MDD7006	38
Door, double, 80% ventilated - 600mm x 41U/73ME (w x h) RAL 9011	MDD7006B	38
Door, double, 80% ventilated - 600mm x 46U/81ME (w x h) RAL 7047	MDD7007	38
Door, double, 80% ventilated - 600mm x 46U/81ME (w x h) RAL 9011	MDD7007B	38
Door, double, 80% ventilated - 800mm x 41U/73ME (w x h) RAL 7047	MDD7106	38
Door, double, 80% ventilated - 800mm x 41U/73ME (w x h) RAL 9011	MDD7106B	38
Door, double, 80% ventilated - 800mm x 46U/81ME (w x h) RAL 7047	MDD7107	38
Door, double, 80% ventilated - 800mm x 46U/81ME (w x h) RAL 9011	MDD7107B	38
Door, double, blank - 600mm x 41U/73ME (w x h) RAL 7047	MDD0006	36
Door, double, blank - 600mm x 46U/81ME (w x h) RAL 7047	MDD0007	36
Door, double, blank - 800mm x 41U/73ME (w x h) RAL 7047	MDD0106	36
Door, double, blank - 800mm x 46U/81ME (w x h) RAL 7047	MDD0107	36
Door, double, glass grey tinted - 600mm x 41U/73ME (w x h) RAL 7047	MDD1016	39
Door, double, glass grey tinted - 600mm x 46U/81ME (w x h) RAL 7047	MDD1017	39
Door, double, glass grey tinted - 800mm x 41U/73ME (w x h) RAL 7047	MDD1116	39
Door, double, glass grey tinted - 800mm x 46U/81ME (w x h) RAL 7047	MDD1117	39
Door, glass clear - 600mm x 12U/21ME (w x h) RAL 7047	MFD1001	34
Door, glass clear - 600mm x 16U/29ME (w x h) RAL 7047	MFD1002	34
Door, glass clear - 600mm x 21U/37ME (w x h) RAL 7047	MFD1003	34
Door, glass clear - 600mm x 25U/45ME (w x h) RAL 7047	MFD1004	34
Door, glass clear - 600mm x 37U/65ME (w x h) RAL 7047	MFD1005	34
Door, glass clear - 600mm x 41U/73ME (w x h) RAL 7047	MFD1006	34
Door, glass clear - 600mm x 41U/73ME (w x h) RAL 9011	MFD1006B	34
Door, glass clear - 600mm x 46U/81ME (w x h) RAL 7047	MFD1007	34
Door, glass clear - 600mm x 46U/81ME (w x h) RAL 9011	MFD1007B	34
Door, glass clear - 800mm x 25U/45ME (w x h) RAL 7047	MFD1104	34
Door, glass clear - 800mm x 37U/65ME (w x h) RAL 7047	MFD1105	34
Door, glass clear - 800mm x 41U/73ME (w x h) RAL 7047	MFD1106	34
Door, glass clear - 800mm x 41U/73ME (w x h) RAL 9011	MFD1106B	34
Door, glass clear - 800mm x 46U/81ME (w x h) RAL 7047	MFD1107	34
Door, glass clear - 800mm x 46U/81ME (w x h) RAL 9011	MFD1107B	34
Door, glass grey tinted - 600mm x 12U/21ME (w x h) RAL 7047	MFD2001	33
Door, glass grey tinted - 600mm x 16U/29ME (w x h) RAL 7047	MFD2002	33
Door, glass grey tinted - 600mm x 21U/37ME (w x h) RAL 7047	MFD2003	33
Door, glass grey tinted - 600mm x 25U/45ME (w x h) RAL 7047	MFD2004	33
Door, glass grey tinted - 600mm x 37U/65ME (w x h) RAL 7047	MFD2005	33
Door, glass grey tinted - 600mm x 41U/73ME (w x h) RAL 7047	MFD2006	33
Door, glass grey tinted - 600mm x 46U/81ME (w x h) RAL 7047	MFD2007	33
Door, glass grey tinted - 800mm x 25U/45ME (w x h) RAL 7047	MFD2104	33
Door, glass grey tinted - 800mm x 37U/65ME (w x h) RAL 7047	MFD2105	33
Door, glass grey tinted - 800mm x 41U/73ME (w x h) RAL 7047	MFD2106	33
Door, glass grey tinted - 800mm x 46U/81ME (w x h) RAL 7047	MFD2107	33
Door, glass grey tinted, ventilated - 800mm x 25U/45ME (w x h) RAL 7047	MFD4114	35
Door, glass grey tinted, ventilated - 800mm x 41U/73ME (w x h) RAL 7047	MFD4116	35
Door, glass grey tinted, ventilated - 800mm x 46U/81ME (w x h) RAL 7047	MFD4117	35
Duopac, 19-inch profiles, set of 2 - 12U (h)	DUO.PR.12.00	106
Duopac, 19-inch profiles, set of 2 - 15U (h)	DUO.PR.15.00	106
Duopac, 19-inch profiles, set of 2 - 3U (h)	DUO.PR.03.00	106
Duopac, 19-inch profiles, set of 2 - 6U (h)	DUO.PR.06.00	106
Duopac, 19-inch profiles, set of 2 - 9U (h)	DUO.PR.09.00	106
Duopac, enclosure - 530 x 450 x 207mm/3U (w x d x h)	DUO.034515	106
Duopac, enclosure - 530 x 450 x 343mm/6U (w x d x h)	DUO.064515	106
Duopac, enclosure - 530 x 450 x 516mm/9U (w x d x h)	DUO.094515	106
Duopac, enclosure - 530 x 450 x 610mm/12U (w x d x h)	DUO.124515	106

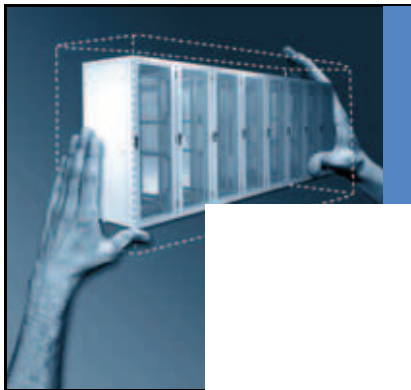

Description	Article no.	Page
Duopac, enclosure - 530 x 450 x 745mm/15U (w x d x h)	DUO.154515	106
E		
E-Line Basic swivel handle - 1 point	MEL0050	115
E-Line Basic swivel handle - 2 points 41HE/73ME (h)	MEL0056	115
E-Line Basic swivel handle - 2 points 46HE/81ME (h)	MEL0057	115
E-Line Basic swivel handle, 2-points Fix Easy lock	MEL0062	115
E-Line Basic swivel handle, 2-points Fix Easy lock	MEL0063	115
E-Line Desktop Reader with IP-port	MEL0110	115
E-Line HID adhesive tag	MEL0116	115
E-Line HID proximity card	MEL0115	115
E-Line HID, configurations cable - serial	MEL0111	115
E-Line HID-485 swivel handle	MEL0020	115
E-Line HID-485 swivel handle - 2 points 41HE/73ME (h)	MEL0026	115
E-Line HID-485 swivel handle - 2 points 46HE/81ME (h)	MEL0027	115
E-Line HID-485 swivel handle, 2-points Fix Easy lock	MEL0042	115
E-Line HID-485 swivel handle, 2-points Fix Easy lock	MEL0043	115
E-Line HID-485, Gateway V3	MEL0113	115
E-Line HID-485, Gateway V3 configuration cable	MEL0114	115
E-Line HID-Direct swivel handle	MEL0010	115
E-Line HID-Direct swivel handle - 2 points 41HE/73ME (h)	MEL0016	115
E-Line HID-Direct swivel handle - 2 points 46HE/81ME (h)	MEL0017	115
E-Line HID-Direct swivel handle, 2-points Fix Easy lock	MEL0032	115
E-Line HID-Direct swivel handle, 2-points Fix Easy lock	MEL0033	115
E-Line Software V3	MEL0112	115
Earthing, cable set MLR	MLR4401	91
Earthing, earthing cables - 3x 200mm and 3x 400mm	MER0001	72
Earthing, earthrail copper - 20 x 5 x 1800mm/73ME (w x d x h)	MER0106	72
Earthing, earthrail copper - 20 x 5 x 2000mm/81ME (w x d x h)	MER0107	72
Earthing, potential equalising rail	MER0003	72
Extension kit, 100mm, for frame 41U/73MU - 600mm (w) RAL 7047	VMF206010	14, 40
Extension kit, 100mm, for frame 41U/73MU - 600mm (w) RAL 9011	VMF206010B	14, 40
Extension kit, 100mm, for frame 41U/73MU - 800mm (w) RAL 7047	VMF208010	14, 40
Extension kit, 100mm, for frame 41U/73MU - 800mm (w) RAL 9011	VMF208010B	14, 40
Extension kit, 100mm, for frame 46U/81MU - 600mm (w) RAL 7047	VMF226010	14, 40
Extension kit, 100mm, for frame 46U/81MU - 600mm (w) RAL 9011	VMF226010B	14, 40
Extension kit, 100mm, for frame 46U/81MU - 800mm (w) RAL 7047	VMF228010	14, 40
Extension kit, 100mm, for frame 46U/81MU - 800mm (w) RAL 9011	VMF228010B	14, 40
F		
Fan unit with IEC connection, incl cabling, UK-plug RAL 7047	MCS1007	127
Fan unit with IEC connection, incl cabling, UK-plug RAL 9011	MCS1007B	127
Fan unit, cable with UK plug RAL 7047	MBM1007	23, 28, 78
Fan unit, cable with UK plug RAL 9011	MBM1007B	23, 28, 78
Filter set for plinths - 600mm (w)	MSM2301	18
Filter set for plinths - 800mm (w)	MSM2302	18
Filter set for ventilation plate	MBM1006	23, 28
Floor fixation set	MSM4100	20
Frame - 600 x 1000 x 1300mm/25U/45ME (w x d x h) RAL 7047	VMF1360100	12
Frame - 600 x 1000 x 2000mm/41U/73ME (w x d x h) RAL 7047	VMF2060100	12
Frame - 600 x 1000 x 2000mm/41U/73ME (w x d x h) RAL 9011	VMF2060100B	12
Frame - 600 x 1000 x 2200mm/46U/81ME (w x d x h) RAL 7047	VMF2260100	12
Frame - 600 x 1000 x 2200mm/46U/81ME (w x d x h) RAL 9011	VMF2260100B	12
Frame - 600 x 1200 x 2000mm/41U/73ME (w x d x h) RAL 7047	VMF2060120	12
Frame - 600 x 1200 x 2000mm/41U/73ME (w x d x h) RAL 9011	VMF2060120B	12
Frame - 600 x 1200 x 2200mm/46U/81ME (w x d x h) RAL 7047	VMF2260120	12
Frame - 600 x 1200 x 2200mm/46U/81ME (w x d x h) RAL 9011	VMF2260120B	12
Frame - 600 x 600 x 1100mm/21U/37ME (w x d x h) RAL 7047	VMF116060	12
Frame - 600 x 600 x 1300mm/25U/45ME (w x d x h) RAL 7047	VMF136060	12
Frame - 600 x 600 x 1800mm/37U/65ME (w x d x h) RAL 7047	VMF186060	12
Frame - 600 x 600 x 2000mm/41U/73ME (w x d x h) RAL 7047	VMF206060	12

Description	Article no.	Page
Frame - 600 x 600 x 2200mm/46U/81ME (w x d x h) RAL 7047	VMF226060	12
Frame - 600 x 600 x 700mm/12U/21ME (w x d x h) RAL 7047	VMF076060	12
Frame - 600 x 600 x 900mm/16U/29ME (w x d x h) RAL 7047	VMF096060	12
Frame - 600 x 800 x 1100mm/21U/37ME (w x d x h) RAL 7047	VMF116080	12
Frame - 600 x 800 x 1300mm/25U/45ME (w x d x h) RAL 7047	VMF136080	12
Frame - 600 x 800 x 1800mm/37U/65ME (w x d x h) RAL 7047	VMF186080	12
Frame - 600 x 800 x 2000mm/41U/73ME (w x d x h) RAL 7047	VMF206080	12
Frame - 600 x 800 x 2200mm/46U/81ME (w x d x h) RAL 7047	VMF226080	12
Frame - 600 x 800 x 700mm/12U/21ME (w x d x h) RAL 7047	VMF076080	12
Frame - 600 x 800 x 900mm/16U/29ME (w x d x h) RAL 7047	VMF096080	12
Frame - 600 x 900 x 1300mm/25U/45ME (w x d x h) RAL 7047	VMF136090	12
Frame - 600 x 900 x 2000mm/41U/73ME (w x d x h) RAL 7047	VMF206090	12
Frame - 600 x 900 x 2200mm/46U/81ME (w x d x h) RAL 7047	VMF226090	12
Frame - 800 x 1000 x 1300mm/25U/45ME (w x d x h) RAL 7047	VMF1380100	12
Frame - 800 x 1000 x 2000mm/41U/73ME (w x d x h) RAL 7047	VMF2080100	12
Frame - 800 x 1000 x 2000mm/41U/73ME (w x d x h) RAL 9011	VMF2080100B	12
Frame - 800 x 1000 x 2200mm/46U/81ME (w x d x h) RAL 7047	VMF2280100	12
Frame - 800 x 1000 x 2200mm/46U/81ME (w x d x h) RAL 9011	VMF2280100B	12
Frame - 800 x 1200 x 2000mm/41U/73ME (w x d x h) RAL 7047	VMF2080120	12
Frame - 800 x 1200 x 2000mm/41U/73ME (w x d x h) RAL 9011	VMF2080120B	12
Frame - 800 x 1200 x 2200mm/46U/81ME (w x d x h) RAL 7047	VMF2280120	12
Frame - 800 x 1200 x 2200mm/46U/81ME (w x d x h) RAL 9011	VMF2280120B	12
Frame - 800 x 600 x 1300mm/25U/45ME (w x d x h) RAL 7047	VMF138060	12
Frame - 800 x 600 x 1800mm/37U/65ME (w x d x h) RAL 7047	VMF188060	12
Frame - 800 x 600 x 2000mm/41U/73ME (w x d x h) RAL 7047	VMF208060	12
Frame - 800 x 600 x 2200mm/46U/81ME (w x d x h) RAL 7047	VMF228060	12
Frame - 800 x 800 x 1300mm/25U/45ME (w x d x h) RAL 7047	VMF138080	12
Frame - 800 x 800 x 1800mm/37U/65ME (w x d x h) RAL 7047	VMF188080	12
Frame - 800 x 800 x 2000mm/41U/73ME (w x d x h) RAL 7047	VMF208080	12
Frame - 800 x 800 x 2200mm/46U/81ME (w x d x h) RAL 7047	VMF228080	12
Frame - 800 x 900 x 1300mm/25U/45ME (w x d x h) RAL 7047	VMF138090	12
Frame - 800 x 900 x 2000mm/41U/73ME (w x d x h) RAL 7047	VMF208090	12
Frame - 800 x 900 x 2200mm/46U/81ME (w x d x h) RAL 7047	VMF228090	12
Front panel aluminium, anodized - 19-inch x 3mm x 12U (w x d x h)	MFA0007	79
Front panel aluminium, anodized - 19-inch x 3mm x 1U (w x d x h)	MFA0001	79
Front panel aluminium, anodized - 19-inch x 3mm x 2U (w x d x h)	MFA0003	79
Front panel aluminium, anodized - 19-inch x 3mm x 3U (w x d x h)	MFA0004	79
Front panel aluminium, anodized - 19-inch x 3mm x 6U (w x d x h)	MFA0005	79
Front panel aluminium, anodized - 19-inch x 3mm x 9U (w x d x h)	MFA0006	79
Front panel, MFE - 19-inch x 1mm x 1U (w x d x h) RAL 7047	MFE0101	80
Front panel, MFE - 19-inch x 1mm x 1U (w x d x h) RAL 9011	MFE0101B	80
Front panel, MFE - 19-inch x 1mm x 2U (w x d x h) RAL 7047	MFE0102	80
Front panel, MFE - 19-inch x 1mm x 2U (w x d x h) RAL 9011	MFE0102B	80
Front panel, MFE - 19-inch x 1mm x 3U (w x d x h) RAL 7047	MFE0103	80
Front panel, MFE - 19-inch x 1mm x 3U (w x d x h) RAL 9011	MFE0103B	80
Front panel, MFE - 19-inch x 1mm x 6U (w x d x h) RAL 7047	MFE0104	80
Front panel, MFE - 19-inch x 1mm x 6U (w x d x h) RAL 9011	MFE0104B	80
Front panel, MFE - 19-inch x 1mm x 9U (w x d x h) RAL 7047	MFE0105	80
Front panel, MFE - 19-inch x 1mm x 9U (w x d x h) RAL 9011	MFE0105B	80
Front panel, MFE - set of 4x MFE0104 RAL 7047	MFE0114	80
Front panel, MFE - set of 4x MFE0104B RAL 9011	MFE0114B	80
Front panel, MFE - set of 6x MFE0101 RAL 7047	MFE0111	80
Front panel, MFE - set of 6x MFE0101B RAL 9011	MFE0111B	80
Front panel, MFE - set of 6x MFE0102 RAL 7047	MFE0112	80
Front panel, MFE - set of 6x MFE0102B RAL 9011	MFE0112B	80
Front panel, MFE - set of 6x MFE0103 RAL 7047	MFE0113	80
Front panel, MFE - set of 6x MFE0103B RAL 9011	MFE0113B	80

H

Heat baffle RAL 7047	MCS2001	128
Heat baffle RAL 9011	MCS2001B	128

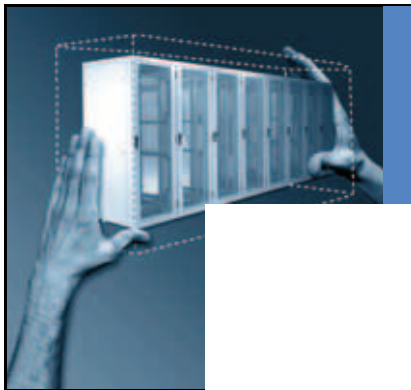

Description	Article no.	Page
I		
Insert module base / top, fan unit, RAL 9011	MBM1004B	92
L		
Lighting set, 19-inch - 600 x 30mm (w x h)	MLS0002	82
Lock, blind stop for swivel handle	MLK9001	44
Lock, for swivel handle, EK-333	MLK9003	44
Lock, square 6mm lock for swivel handle	MLK9002	44
Lock, wilka lock for swivel handle	MLK9004	44
Locking mechanism internal left - 1000mm (d)	MSA0301	51
Locking mechanism internal left - 600mm (d)	MSA0001	51
Locking mechanism internal left - 800mm (d)	MSA0101	51
Locking mechanism internal left - 900mm (d)	MSA0201	51
Locking mechanism internal right - 1000mm (d)	MSA0302	51
Locking mechanism internal right - 600mm (d)	MSA0002	51
Locking mechanism internal right - 800mm (d)	MSA0102	51
Locking mechanism internal right - 900mm (d)	MSA0202	51
M		
MWE, 19-inch profiles, set of 2 - 12U (h)	MWEPR12	101
MWE, 19-inch profiles, set of 2 - 15U (h)	MWEPR15	101
MWE, 19-inch profiles, set of 2 - 21U (h)	MWEPR21	101
MWE, 19-inch profiles, set of 2 - 6U (h)	MWEPR06	101
MWE, 19-inch profiles, set of 2 - 9U (h)	MWEPR09	101
MWE, cable entry brush	MWECEB01	103
MWE, cable ring 19-inch mounted	MWECEM01	103
MWE, corner guide rails, set of 2 - 1U (h)	MWECS01	104
MWE, door, metal, powder coated - 12U (h)	MWEMD12	100
MWE, door, metal, powder coated - 15U (h)	MWEMD15	100
MWE, door, metal, powder coated - 21U (h)	MWEMD21	100
MWE, door, metal, powder coated - 6U (h)	MWEMD06	100
MWE, door, metal, powder coated - 9U (h)	MWEMD09	100
MWE, thermostate	MWETF02	101
MWE, top plate with fan unit - 425mm (d)	MWEFP-425-UK	100
MWE, top plate with fan unit - 525mm (d)	MWEFP-525-UK	100
MWE, top plate with fan unit - 625mm (d)	MWEFP-625-UK	100
MWE, wall enclosure - 600 x 425 x 342mm/6HE (w x d x h)	MWE06425G	99
MWE, wall enclosure - 600 x 425 x 476mm/9HE (w x d x h)	MWE09425G	99
MWE, wall enclosure - 600 x 425 x 609mm/12HE (w x d x h)	MWE12425G	99
MWE, wall enclosure - 600 x 525 x 1009mm/21HE (w x d x h)	MWE21525G	99
MWE, wall enclosure - 600 x 525 x 342mm/6HE (w x d x h)	MWE06525G	99
MWE, wall enclosure - 600 x 525 x 476mm/9HE (w x d x h)	MWE09525G	99
MWE, wall enclosure - 600 x 525 x 609mm/12HE (w x d x h)	MWE12525G	99
MWE, wall enclosure - 600 x 525 x 742mm/15HE (w x d x h)	MWE15525G	99
MWE, wall enclosure - 600 x 625 x 1009mm/21HE (w x d x h)	MWE21625G	99
MWE, wall enclosure - 600 x 625 x 476mm/9HE (w x d x h)	MWE09625G	99
MWE, wall enclosure - 600 x 625 x 609mm/12HE (w x d x h)	MWE12625G	99
MWE, wall enclosure - 600 x 625 x 742mm/15HE (w x d x h)	MWE15625G	99
Mounting depth post - 1000mm (d)	MPR0153	59
Mounting depth post - 1200mm (d)	MPR0154	59
Mounting depth post - 600mm (d)	MPR0150	59
Mounting depth post - 800mm (d)	MPR0151	59
Mounting depth post - 900mm (d)	MPR0152	59
Mounting material, plate screws, 22 pieces	MWEXS01	105
Mounting width post - 600mm (w)	MPR0100	60
Mounting width post - 800mm (w)	MPR0101	60
Mounting-brackets universal (set of 4)	MCE0410	69
P		
Plinth 100mm front/rear, blank - 600mm (w) RAL 7047	MSM2101	18
Plinth 100mm front/rear, blank - 600mm (w) RAL 9011	MSM2101B	18

Description	Article no.	Page
Plinth 100mm front/rear, blank - 800mm (w) RAL 7047	MSM2201	18
Plinth 100mm front/rear, blank - 800mm (w) RAL 9011	MSM2201B	18
Plinth 100mm front/rear, perforated - 600mm (w) RAL 7047	MSM2102	18
Plinth 100mm front/rear, perforated - 600mm (w) RAL 9011	MSM2102B	18
Plinth 100mm front/rear, perforated - 800mm (w) RAL 7047	MSM2202	18
Plinth 100mm front/rear, perforated - 800mm (w) RAL 9011	MSM2202B	18
Plinth 100mm side, blank - 1000mm (d)	MSM2503	18
Plinth 100mm side, blank - 1000mm (d) RAL 9011	MSM2503B	18
Plinth 100mm side, blank - 1200mm (d) RAL 7047	MSM2603B	18
Plinth 100mm side, blank - 600mm (d) RAL 7047	MSM2103	18
Plinth 100mm side, blank - 800mm (d) RAL 7047	MSM2203	18
Plinth 100mm side, blank - 900mm (d)	MSM2403	18
Plinth 100mm side, perforated - 1000mm (d) RAL 9011	MSM2504B	18
Plinth 100mm side, perforated - 1200mm (d) RAL 9011	MSM2604B	18
Plinth 100mm side, perforated - 600mm (d) RAL 7047	MSM2104	18
Plinth 100mm side, perforated - 800mm (d) RAL 7047	MSM2204	18
Plinth 25mm front/rear, blank - 600mm (w) RAL 7047	MSM1101	16
Plinth 25mm front/rear, blank - 600mm (w) RAL 9011	MSM1101B	16
Plinth 25mm front/rear, blank - 800mm (w) AG2RAL 9011	MSM1201B	16
Plinth 25mm front/rear, blank - 800mm (w) RAL 7047	MSM1201	16
Plinth 25mm front/rear, perforated - 600mm (w) RAL 7047	MSM1102	16
Plinth 25mm front/rear, perforated - 600mm (w) RAL 9011	MSM1102B	16
Plinth 25mm front/rear, perforated - 800mm (w) RAL 7047	MSM1202	16
Plinth 25mm front/rear, perforated - 800mm (w) RAL 9011	MSM1202B	16
Plinth 25mm side, blank - 1000mm (d) RAL 7047	MSM1403	17
Plinth 25mm side, blank - 1000mm (d) RAL 9011	MSM1403B	17
Plinth 25mm side, blank - 1200mm (d) RAL 7047	MSM1503	17
Plinth 25mm side, blank - 1200mm (d) RAL 9011	MSM1503B	17
Plinth 25mm side, blank - 600mm (d) RAL 7047	MSM1103	17
Plinth 25mm side, blank - 800mm (d) RAL 7047	MSM1203	17
Plinth 25mm side, blank - 900mm (d) RAL 7047	MSM1303	17
Plinth front/rear (in combination with castors) - 600mm (w) RAL 7047	MSM3101	19
Plinth front/rear (in combination with castors) - 800mm (w) RAL 7047	MSM3201	19
Plinth side (in combination with castors) - 1000mm (d) RAL 7047	MSM3403	19
Plinth side (in combination with castors) - 600mm (d) RAL 7047	MSM3103	19
Plinth side (in combination with castors) - 800mm (d) RAL 7047	MSM3203	19
Plinth side (in combination with castors) - 900mm (d) RAL 7047	MSM3303	19
Power socket aluminium, SCHUKO, 9-voudig	MLR4001	93
Power socket aluminium, UTE, 9-voudig	MLR4021	93
Power socket plastic, SCHUKO, 6-voudig	MLR4041	94
Power socket plastic, UTE, 6-voudig	MLR4061	94
Power strip aluminium, 13 sockets	MPS4001	71
Power strip aluminium, 19 sockets	MPS4002	71
Power strip aluminium, 19-inch mounting, 7 sockets	MPS4003	71
Power strip aluminium, IEC-320, 12-head	MPS5002	70
Power strip aluminium, IEC-320, 16-head	MPS5003	70
Power strip aluminium, IEC-320, 19-inch mounting, 8-sockets	MPS5004	70
Power strip aluminium, IEC-320, 8-head	MPS5001	70
Power strip aluminium, mounting set	MPS0097	71
Profile for dividing the rear side - 600mm (w)	MRA0001	46
Profile for dividing the rear side - 800mm (w)	MRA0002	46
Profile for dividing the side panel - 600mm (d)	MSA0100	52
Profile for dividing the side panel - 800mm (d)	MSA0200	52
Profiles, 19-inch, set of 2 - 12U/21ME (h)	MPR0501	54
Profiles, 19-inch, set of 2 - 16U/29ME (h)	MPR0502	54
Profiles, 19-inch, set of 2 - 21U/37ME (h)	MPR0503	54
Profiles, 19-inch, set of 2 - 25U/45ME (h)	MPR0504	54
Profiles, 19-inch, set of 2 - 37U/65ME (h)	MPR0505	54
Profiles, 19-inch, set of 2 - 41U/73ME (h)	MPR0506	54
Profiles, 19-inch, set of 2 - 46U/81ME (h)	MPR0507	54
Profiles, metric, set of 2 - 21ME (h)	MPR1001	55
Profiles, metric, set of 2 - 29ME (h)	MPR1002	55
Profiles, metric, set of 2 - 37ME (h)	MPR1003	55
Profiles, metric, set of 2 - 45ME (h)	MPR1004	55

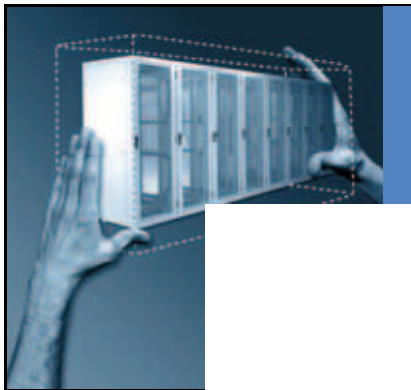

Description	Article no.	Page
Profiles, metric, set of 2 - 65ME (h)	MPR1005	55
Profiles, metric, set of 2 - 73ME (h)	MPR1006	55
Profiles, metric, set of 2 - 81ME (h)	MPR1007	55
Profiles, number strip for 19-inch profile 46U (h)	MPR0060	55
Profiles, number strip for metric profile 81ME (h)	MPR0061	55
Pull relief, adjustable	MPR0251	58

R

RMS, 4-20mA converter, cable length 1,5m	MRM0116	119
RMS, 8 port unit - incl. CD and power supply	MRM0010	119
RMS, 8 port unit with 20 dry-contacts - incl. CD and power supply	MRM0020	119
RMS, AC-voltage detector -1,5m	MRM0112	119
RMS, Airflow sensor - 1,5m	MRM0109	119
RMS, DC-volt sensor - 1,5m	MRM0115	119
RMS, Dry-contact cable - 4,5 m	MRM0113	119
RMS, Motion detector -1,5m	MRM0110	119
RMS, Relais board -1,5m	MRM0114	119
RMS, Smoke detector -1,5m	MRM0111	119
RMS, base kit	MRM0002	119
RMS, door switch 2,5m	MRM0103	119
RMS, double sensor air humidity and intelligent temperature with RJ-45 port	MRM0117	119
RMS, intelligent temperature sensor 1m	MRM0101	119
RMS, intelligent temperature sensor 2,5m	MRM0102	119
RMS, intelligent temperature sensor with RJ-45 port	MRM0118	119
RMS, power supply 100/230 VAC, 9VDC 300 mA	MRM0204	119
RMS, water detector 4,5 m	MRM0105	119
Rack, MLR - base frame, 800 x 800 x 2000mm 42HE (b x d x h)	MLR0111	88
Rack, MLR - baying rack, 800 x 800 x 2000mm 42HE (b x d x h)	MLR1111	87
Rack, MLR - stand alone rack, 800 x 800 x 2000mm 42HE (b x d x h)	MLR2111	87
Rear panel - 600mm x 12U/21ME (w x h) RAL 7047	MRP0001	45
Rear panel - 600mm x 16U/29ME (w x h) RAL 7047	MRP0002	45
Rear panel - 600mm x 21U/37ME (w x h) RAL 7047	MRP0003	45
Rear panel - 600mm x 25U/45ME (w x h) RAL 7047	MRP0004	45
Rear panel - 600mm x 37U/65ME (w x h) RAL 7047	MRP0005	45
Rear panel - 600mm x 41U/73ME (w x h) RAL 7047	MRP0006	45
Rear panel - 600mm x 46U/81ME (w x h) RAL 7047	MRP0007	45
Rear panel - 800mm x 25U/45ME (w x h) RAL 7047	MRP0104	45
Rear panel - 800mm x 37U/65ME (w x h) RAL 7047	MRP0105	45
Rear panel - 800mm x 41U/73ME (w x h) RAL 7047	MRP0106	45
Rear panel - 800mm x 46U/81ME (w x h) RAL 7047	MRP0107	45

S

Screws, decorative, with washer (black) M5 - (100 pieces)	MFM0011	68
Screws, decorative, with washer (black) M5 - (20 pieces)	MFM0010	68, 105
Screws, decorative, with washer (black) M6 - (100 pieces)	MFM0013	68
Screws, decorative, with washer (black) M6 - (20 pieces)	MFM0012	68, 105
Shelf, MFE - 19-inch x 250 x 18,5mm (w x d x h) RAL 7047	MFE0001	62
Shelf, MFE - 19-inch x 350 x 18,5mm (w x d x h) RAL 7047	MFE0002	62
Shelf, MFE - 19-inch x 500 x 18,5mm (w x d x h) RAL 7047	MFE0003	62
Shelf, MFE - 19-inch x 650 x 18,5mm (w x d x h) RAL 7047	MFE0004	62
Shelf, MFE - 19-inch x 650 x 18,5mm (w x d x h) RAL 9011	MFE0004B	62
Shelf, MFE - 19-inch x 800 x 18,5mm (w x d x h) RAL 7047	MFE0005	62
Shelf, MFE - 19-inch x 800 x 18,5mm (w x d x h) RAL 9011	MFE0005B	62
Shelf, MFE - fixing clips, set of 4 pieces	MFE0020	62
Shelf, cable guide for telescopic shelf	MPA0003	66
Shelf, cantilever - 19-inch x 250mm x 2U (w x d x h) RAL 7047	MPL0311	64, 102, 107, 110
Shelf, cantilever - 19-inch x 350mm x 2U (w x d x h) RAL 7047	MPL0312	64, 102, 107, 110
Shelf, cantilever - 19-inch x 350mm x 2U (w x d x h) RAL 9011	MPL0312B	64
Shelf, full size fixed - 600 x 600mm (w x d) RAL 7047	MPL0411	65
Shelf, full size fixed - 600 x 800mm (w x d) RAL 7047	MPL0412	65
Shelf, full size fixed - 800 x 600mm (w x d) RAL 7047	MPL0511	65

Description	Article no.	Page
Shelf, full size fixed - 800 x 800mm (w x d) RAL 7047	MPL0512	65
Shelf, full size on telescopic rails - 600 x 600mm (w x d) RAL 7047	MPL0611	66
Shelf, full size on telescopic rails - 600 x 800mm (w x d) RAL 7047	MPL0612	66
Shelf, full size on telescopic rails - 800 x 600mm (w x d) RAL 7047	MPL0711	66
Shelf, full size on telescopic rails - 800 x 800mm (w x d) RAL 7047	MPL0712	66
Shelf, stiffener rib for full size shelves - 500mm (d)	MPA0010	67
Shelf, stiffener rib for full size shelves - 700mm (d)	MPA0011	67
Shelf, telescopic - 19-inch x 300 x 55mm (w x d x h) RAL 7047	MPL0110	64, 102, 107, 110
Shelf, telescopic - 19-inch x 350 x 55mm (w x d x h) RAL 7047	MPL0111	64, 110
Shelf, telescopic - 19-inch x 500 x 55mm (w x d x h) RAL 7047	MPL0112	64
Shelf, telescopic - 19-inch x 700 x 55mm (w x d x h) RAL 7047	MPL0113	64
Shelf, telescopic keyboard - build-in 400 - 700mm RAL 7047	MPK0001	65
Shelf, telescopic keyboard - build-in 600 - 900mm RAL 7047	MPK0002	65
Shelf, telescopic keyboard - build-in 600 - 900mm RAL 9011	MPK0002B	65
Shelf, variable - 19-inch x 250 x 12mm (w x d x h) RAL 7047	MPL0010	63, 102, 107, 110
Shelf, variable - 19-inch x 350 x 12mm (w x d x h) RAL 7047	MPL0011	63, 102, 107, 110
Shelf, variable - 19-inch x 500 x 12mm (w x d x h) RAL 7047	MPL0012	63
Shelf, variable - 19-inch x 700 x 12mm (w x d x h) RAL 7047	MPL0013	63
Shelf, variable 100kg - 19-inch x 700 x 25mm (w x d x h) RAL 7047	MPL0014	63
Shelf, variable 100kg - 19-inch x 700 x 25mm (w x d x h) RAL 9011	MPL0014B	63
Shelf, variable 100kg - 19-inch x 800 x 25mm (w x d x h) RAL 7047	MPL0015	63
Shelf, variable 100kg - 19-inch x 800 x 25mm (w x d x h) RAL 9011	MPL0015B	63
Shunting comb with 4 teeth, 19-inch	MCM0011	76, 104
Shunting eye front mounting 1,5U - 52 x 86mm (w x d)	MCM0003	73, 95
Shunting eye front mounting 1U - 30 x 86mm (w x d)	MCM0002	73, 95, 103
Shunting eye front mounting 2U - 74 x 86mm (w x d)	MCM0004	74
Shunting eye front mounting vertical - 35 x 64mm (w x d)	MCM0001	73, 95, 102
Shunting eye side mounting, 19-inch - 110 x 154mm (w x d)	MCM0007	74, 96
Shunting eye, side, height post - 130 x 120mm (w x d)	MCM0009	75
Shunting eye, side, height post - 85 x 165mm (w x d)	MCM0008	74
Side panel - 1000mm x 25U/45ME (d x h) RAL 7047	MSP0304	50
Side panel - 1000mm x 41U/73ME (d x h) RAL 7047	MSP0306	50
Side panel - 1000mm x 41U/73ME (d x h) RAL 9011	MSP0306B	50
Side panel - 1000mm x 46U/81ME (d x h) RAL 7047	MSP0307	50
Side panel - 1000mm x 46U/81ME (d x h) RAL 9011	MSP0307B	50
Side panel - 1200mm x 41U/73ME (d x h) RAL 7047	MSP0406	50
Side panel - 1200mm x 41U/73ME (d x h) RAL 9011	MSP0406B	50
Side panel - 1200mm x 46U/81ME (d x h) RAL 7047	MSP0407	50
Side panel - 1200mm x 46U/81ME (d x h) RAL 9011	MSP0407B	50
Side panel - 600mm x 12U/21ME (d x h) RAL 7047	MSP0001	50
Side panel - 600mm x 16U/29ME (d x h) RAL 7047	MSP0002	50
Side panel - 600mm x 21U/37ME (d x h) RAL 7047	MSP0003	50
Side panel - 600mm x 25U/45ME (d x h) RAL 7047	MSP0004	50
Side panel - 600mm x 37U/65ME (d x h) RAL 7047	MSP0005	50
Side panel - 600mm x 41U/73ME (d x h) RAL 7047	MSP0006	50
Side panel - 600mm x 46U/81ME (d x h) RAL 7047	MSP0007	50
Side panel - 800mm x 12U/21ME (d x h) RAL 7047	MSP0101	50
Side panel - 800mm x 16U/29ME (d x h) RAL 7047	MSP0102	50
Side panel - 800mm x 21U/37ME (d x h) RAL 7047	MSP0103	50
Side panel - 800mm x 25U/45ME (d x h) RAL 7047	MSP0104	50
Side panel - 800mm x 37U/65ME (d x h) RAL 7047	MSP0105	50
Side panel - 800mm x 41U/73ME (d x h) RAL 7047	MSP0106	50
Side panel - 800mm x 46U/81ME (d x h) RAL 7047	MSP0107	50
Side panel - 900mm x 25U/45ME (d x h) RAL 7047	MSP0204	50
Side panel - 900mm x 41U/73ME (d x h) RAL 7047	MSP0206	50
Side panel - 900mm x 46U/81ME (d x h) RAL 7047	MSP0207	50
Side panel MLR, 800mm x 42HE (d x h)	MLR3411	90
Side skirt seal kit - rubber	MCS0010	127
Side skirt side panels - for 41U cabinets RAL 7047	MCS0016	126

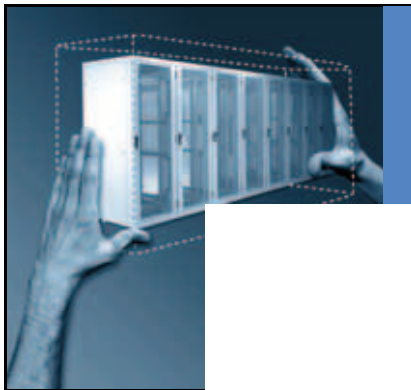

Description	Article no.	Page
Side skirt side panels - for 41U cabinets RAL 9011	MCS0016B	126
Side skirt side panels - for 46U cabinets RAL 7047	MCS0017	126
Side skirt side panels - for 46U cabinets RAL 9011	MCS0017B	126
Side skirts, 19-inch - for 41U x 800mm cabinets RAL 7047	MCS0006	126
Side skirts, 19-inch - for 41U x 800mm cabinets RAL 9011	MCS0006B	126
Side skirts, 19-inch - for 41U x 800mm cabinets RAL 9011	MCS0007B	126
Side skirts, 19-inch - for 46U x 800mm cabinets RAL 7047	MCS0007	126
Stability posts 19-inch - 600 x 1000mm (w x d)	MPR0183	57
Stability posts 19-inch - 600 x 1200mm (w x d)	MPR0184	57
Stability posts 19-inch - 600 x 600mm (w x d)	MPR0180	57
Stability posts 19-inch - 600 x 800mm (w x d)	MPR0181	57
Stability posts 19-inch - 600 x 900mm (w x d)	MPR0182	57
Stability posts 19-inch - 800 x 1000mm (w x d)	MPR1183	57
Stability posts 19-inch - 800 x 1200mm (w x d)	MPR1184	57
Stability posts 19-inch - 800 x 600mm (w x d)	MPR1180	57
Stability posts 19-inch - 800 x 800mm (w x d)	MPR1181	57
Stability posts 19-inch - 800 x 900mm (w x d)	MPR1182	57
Stiffener profile for base plate - 1000mm RAL 7047	MBM0043	22
Stiffener profile for base plate - 1200mm	MBM0044	22
Stiffener profile for base plate - 600mm RAL 7047	MBM0040	22
Stiffener profile for base plate - 800mm RAL 7047	MBM0041	22
Stiffener profile for base plate - 900mm RAL 7047	MBM0042	22
Support spacer 100mm	MPR0050	59
Swivel handle, 1-point lock	MLK0300	43
Swivel handle, 1-point with combination lock	MLK0320	43
Swivel handle, 2-points Fix Easy lock	MLK0501	42
Swivel handle, 2-points Fix Easy lock	MLK0502	42
Swivel handle, 2-points Fix Easy lock	MLK0503	42
Swivel handle, 2-points Fix Easy lock, with combination lock	MLK0531	42
Swivel handle, 2-points Fix Easy lock, with combination lock	MLK0532	42
Swivel handle, 2-points Fix Easy lock, with combination lock	MLK0533	42
Swivel handle, 2-points lock - 25U/45ME (h)	MLK0304	43
Swivel handle, 2-points lock - 37U/65ME (h)	MLK0305	43
Swivel handle, 2-points lock - 41U/73ME (h)	MLK0306	43
Swivel handle, 2-points lock - 46U/81ME (h)	MLK0307	43
Swivel handle, 2-points with combination lock - 25U/45ME (h)	MLK0324	43
Swivel handle, 2-points with combination lock - 37U/65ME (h)	MLK0325	43
Swivel handle, 2-points with combination lock - 41U/73ME (h)	MLK0326	43
Swivel handle, 2-points with combination lock - 46U/81ME (h)	MLK0327	43

T

TFT drawer 19" - incl front USB port FR layout	MTD0002	83
TFT drawer 19" - incl front USB port GE layout	MTD0003	83
TFT drawer 19-inch - incl. front USB port US layout	MTD0001	83
Thermostat for fan-units	MCC0300	78
Third hand, MFE - assembly tool	MFE0050	69
Top, MLR - 800 x 800mm	MLR3111	92
Top, blank, 3 cut-outs F/R - 600 x 1000mm (w x d) RAL 7047	MRF0027	27
Top, blank, 3 cut-outs F/R - 600 x 1000mm (w x d) RAL 9011	MRF0027B	27
Top, blank, 3 cut-outs F/R - 600 x 1200mm (w x d) RAL 7047	MRF0030	27
Top, blank, 3 cut-outs F/R - 600 x 1200mm (w x d) RAL 9011	MRF0030B	27
Top, blank, 3 cut-outs F/R - 600 x 600mm (w x d) RAL 7047	MRF0017	27
Top, blank, 3 cut-outs F/R - 600 x 800mm (w x d) RAL 7047	MRF0018	27
Top, blank, 3 cut-outs F/R - 600 x 900mm (w x d) RAL 7047	MRF0025	27
Top, blank, 3 cut-outs L/R - 800 x 600mm (w x d) RAL 7047	MRF0119	27
Top, blank, 3 cut-outs L/R - 800 x 800mm (w x d) RAL 7047	MRF0120	27
Top, blank, 4 cut-outs L/R - 800 x 1000mm (w x d) RAL 7047	MRF0028	27
Top, blank, 4 cut-outs L/R - 800 x 1000mm (w x d) RAL 9011	MRF0028B	27
Top, blank, 4 cut-outs L/R - 800 x 1200mm (w x d) RAL 7047	MRF0029	27
Top, blank, 4 cut-outs L/R - 800 x 1200mm (w x d) RAL 9011	MRF0029B	27
Top, blank, 4 cut-outs L/R - 800 x 900mm (w x d) RAL 7047	MRF0026	27
Top, ventilated, 3 cut-outs F/R - 600 x 600mm (w x d) RAL 7047	MRF0021	26
Top, ventilated, 3 cut-outs F/R - 600 x 800mm (w x d) RAL 7047	MRF0022	26

Description	Article no.	Page
Top, ventilated, 3 cut-outs L/R - 800 x 600mm (w x d) RAL 7047	MRF0123	26
Top, ventilated, 3 cut-outs L/R - 800 x 800mm (w x d) RAL 7047	MRF0124	26
Tripac, 19-inch profiles, set of 2 - 12U (h)	TRI.PR.12.00	109
Tripac, 19-inch profiles, set of 2 - 15U (h)	TRI.PR.15.00	109
Tripac, 19-inch profiles, set of 2 - 18U (h)	TRI.PR.18.00	109
Tripac, 19-inch profiles, set of 2 - 21U (h)	TRI.PR.21.00	109
Tripac, 19-inch profiles, set of 2 - 21U (h)	TRI.VP.00.01	108, 110
Tripac, 19-inch profiles, set of 2 - 6U (h)	TRI.PR.06.00	109
Tripac, 19-inch profiles, set of 2 - 9U (h)	TRI.PR.09.00	109
Tripac, fan unit with IEC connection	TRI.VE.00.02	111
Tripac, wall enclosure - 600 x 500 x 1011mm/21HE (w x d x h)	TRI.215015	109
Tripac, wall enclosure - 600 x 500 x 345mm/6HE (w x d x h)	TRI.065015	109
Tripac, wall enclosure - 600 x 500 x 478mm/9HE (w x d x h)	TRI.095015	109
Tripac, wall enclosure - 600 x 500 x 611mm/12HE (w x d x h)	TRI.125015	109
Tripac, wall enclosure - 600 x 500 x 744mm/15HE (w x d x h)	TRI.155015	109
Tripac, wall enclosure - 600 x 500 x 878mm/18HE (w x d x h)	TRI.185015	109

V

Velcro tapes (100 pieces)	MCM0100	76, 104
Velcro, double-sided roll	FDH0420	76, 104
Ventilation plate RAL 7047	MBM1005	23, 28
Ventilation plate RAL 9011	MBM1005B	23, 28

W

Wall mounting - 600mm (w)	MRW0001	47
---------------------------	---------	----



Minkels Netherlands
Eisenhowerweg 12
P.O. Box 28
5460 AA Veghel
Tel. +31 (0)413 311 100
Fax +31 (0)413 311 102
info@minkels.com
www.minkels.com

Minkels Germany
Merianstraße 27
66424 Homburg
Tel. +49 (0)6841 98499 0
Fax. +49 (0)6841 98499 20
info-de@minkels.com
www.minkels.com

Minkels Belgium
Remysite
Remylaan 4C - Bus 12
3018 Wijgmaal (Leuven)
Tel. +32 (0)16 44 2010
Fax. +32 (0)16 44 2011
info-be@minkels.com
www.minkels.com

Minkels France
Parc d'activités de Malnoue
28, Rue Vlad. Jankelevitch
77184 Emerainville
Tel. +33 (0)164 61 61 91
Fax. +33 (0)164 61 73 82
info-fr@minkels.com
www.minkels.com

Minkels Switzerland
Riedstrasse 3-5
CH-6330 Cham
Tel. +41 (0)41 748 4060
Fax. +41 (0)41 748 4079
info-ch@minkels.com
www.minkels.ch

Minkels United Kingdom
Unit 6, Union Way
Hillbottom Road
Sands Industrial Estate
High Wycombe
Bucks, HP12 4HJ
Tel. +44 (0)1494 451706
Fax. +44 (0)1494 451736
info-uk@minkels.com
www.minkels.com